

Alüminyum'un Sanata Dönüşümü...



PETRA ISI CAMLI SÜRME SİSTEMİ
PETRA HEAT GLASS SLIDING SYSTEMS

www.kenanmetal.com



Aluminum Profile Systems



Aluminum Profile Systems

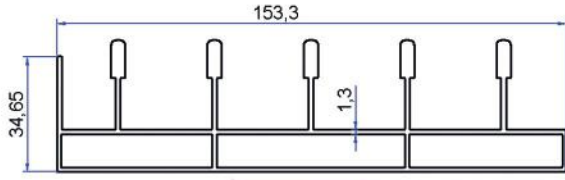

Profile No	kg/m
	2,274

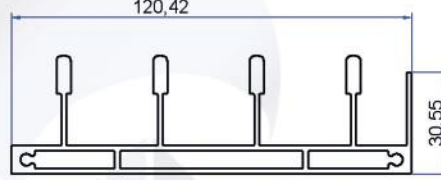

Profile No	kg/m
2470	2,092

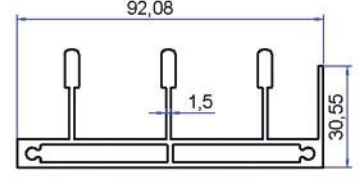

Profile No	kg/m
2469	1,631

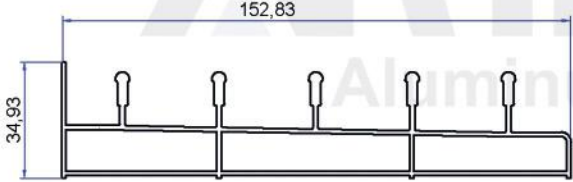

Profile No	kg/m
	1,922

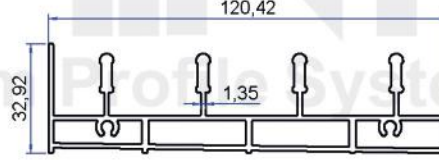

Profile No	kg/m
2377	1,818

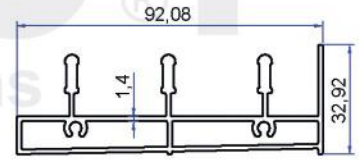

Profile No	kg/m
2355	1,369

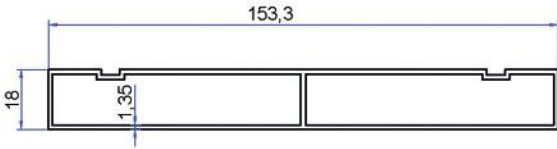

Profile No	kg/m
	1,314

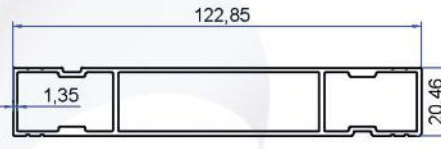

Profile No	kg/m
2376	1,266

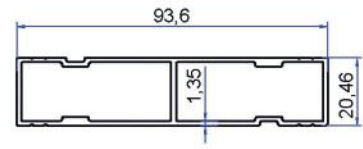

Profile No	kg/m
2357	0,962

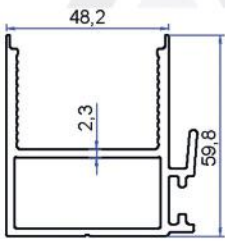

Profile No	kg/m
2467	0,404

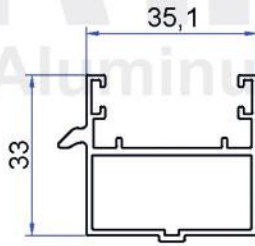

Profile No	kg/m
3268	0,554

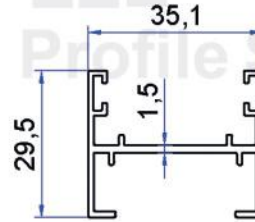

Profile No	kg/m
3270	0,420

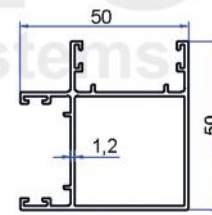

Profile No	kg/m
3271	0,748

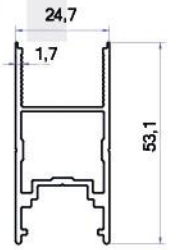

Profile No	kg/m
3568	0,675

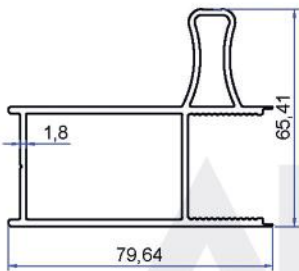

Profile No	kg/m
3216	0,702

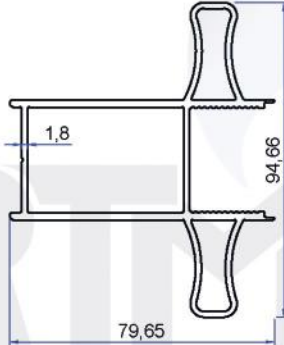

Profile No	kg/m
3215	0,848

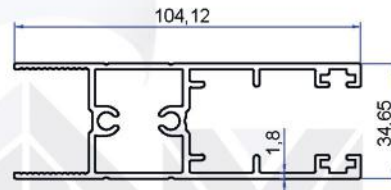

Profile No	kg/m
2356	0,764

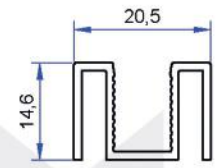

Profile No	kg/m
3269	0,233

Isı Camlı 3'lü Sürme Sistemleri
Heat Glazed 3 Sliding Systems

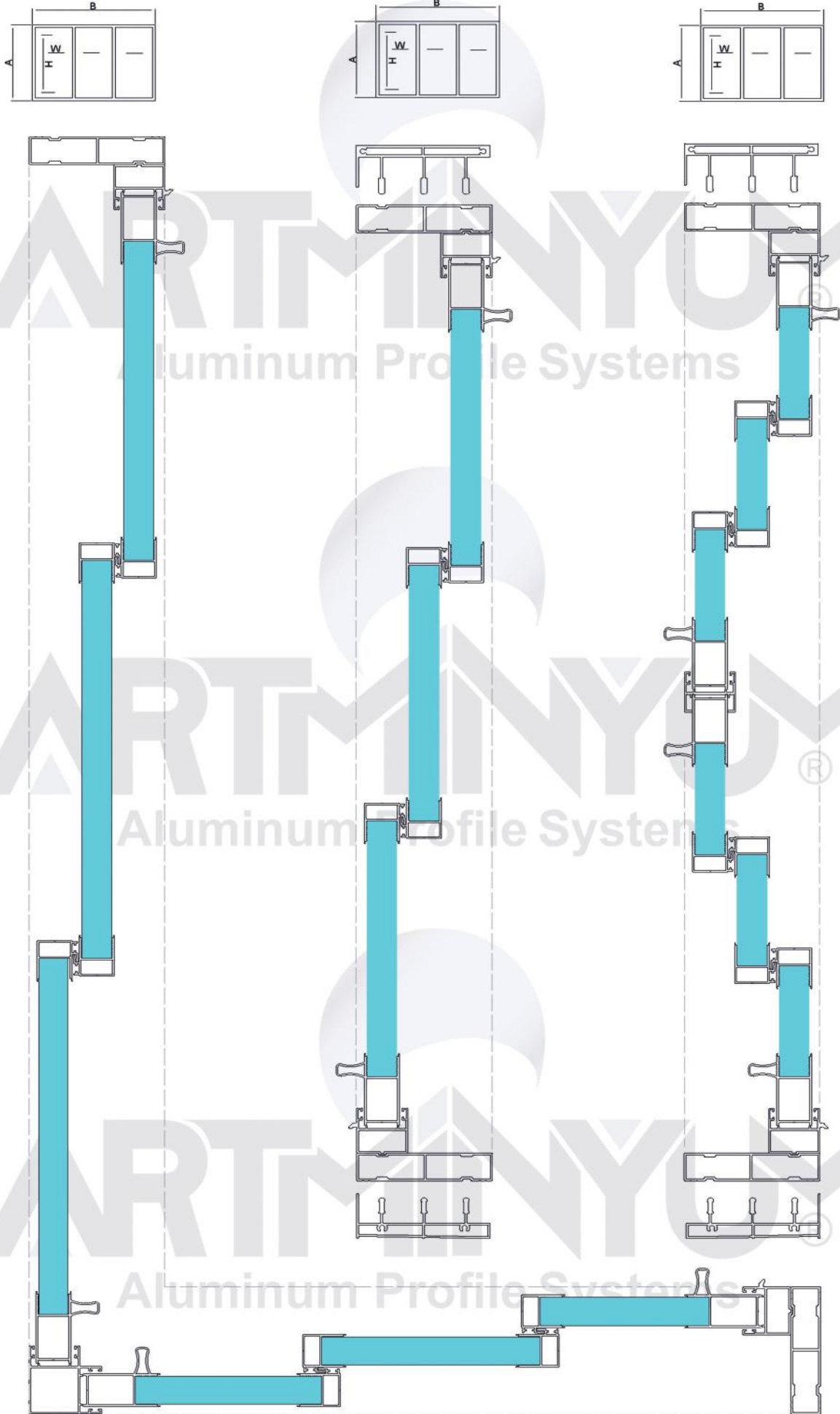

Isı Camlı 4'lü Sürme Sistemleri
Heat Glazed 4 Sliding Systems

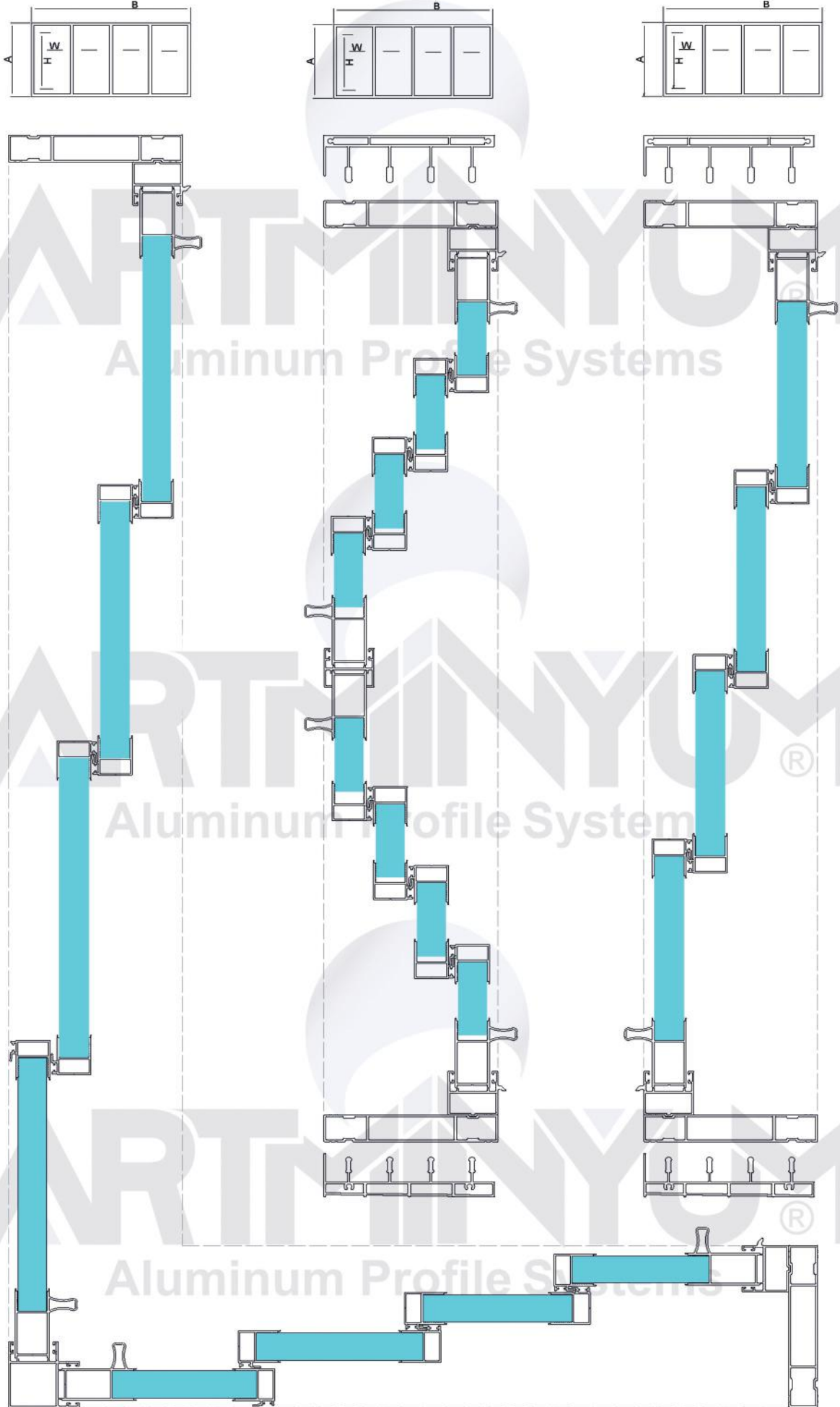

Isı Camlı 5'lü Sürme Sistemleri
Heat Glazed 5 Sliding Systems

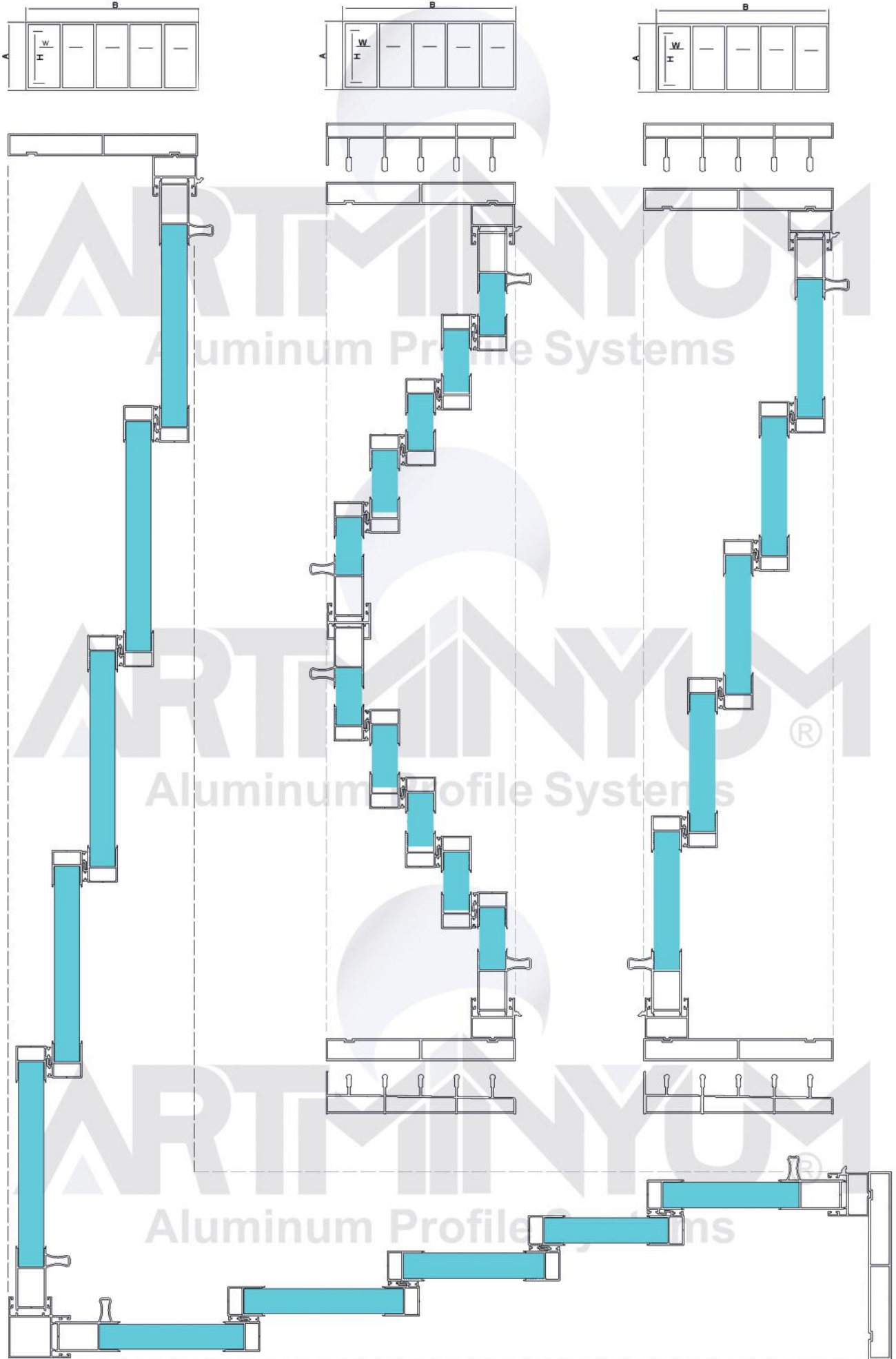

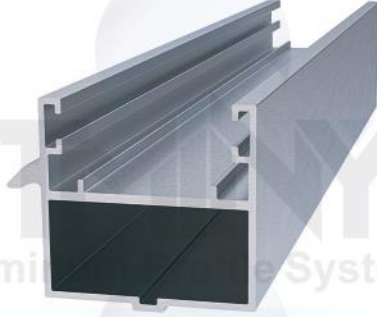

Yan Baza İç Profili
Side Base Internal Profile

Product Code:3268

Weight kg/m: 0,554
(34,2x 35,1 x 1,2mm)



Orta Birleşim Profili
Medium Joint Profile

Product Code:3270

Weight kg/m: 0,420
(29,5 x 35,1 x 1,2mm)



Köşe Dönüş profili
Corner Turn profile

Product Code:3271

Weight kg/m: 0,748
(50 x 50 x 1,2mm)

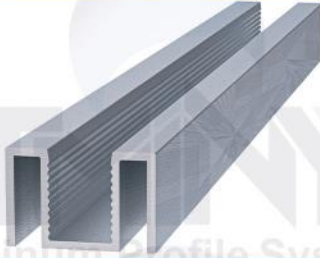

8mm Cam Adaptörü
8mm Glass Adapter

Product Code:3269

Weight kg/m: 0,233
(14,6 x 20,6 x 1,2mm)

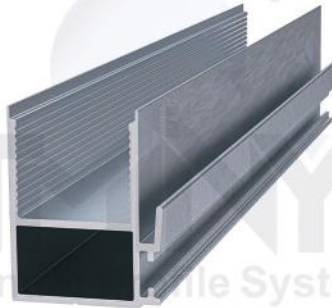

Baza Kenet Profili
Base Clamp Profile

Product Code:2467

Weight kg/m: 0,404
(29,9 x 24,1 x 1,2mm)

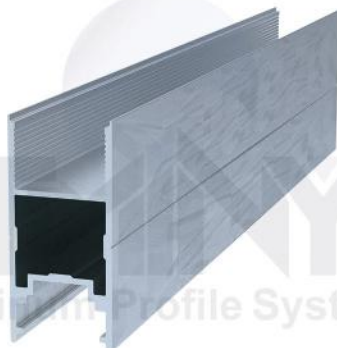

İspanyolet Profili
Espagnolette Profile

Product Code:3568

Weight kg/m: 0,675
(24,7 x 53,1 x 1,7mm)



5'li Üst Baza Profili
5 Pcs Upper Base Profile

Product Code:

Weight kg/m:2,274
(153,3 x 39,6 x 1,5mm)



5'li Alt Baza Profili
5 Pcs Bottom Base Profile

Product Code:

Weight kg/m: 1,922
(153,29 x 34,93 x 1,3mm)



4'lü Alt Baza Profili
4 Pcs Bottom Base Profile

Product Code:2377

Weight kg/m: 1,818
(120,42x 32,92 x 1,35mm)



4'lü Üst Baza Profili
4 Pcs Upper Base Profile

Product Code:2470

Weight kg/m: 2,092
(120,42 x 35,5 x 1,5mm)

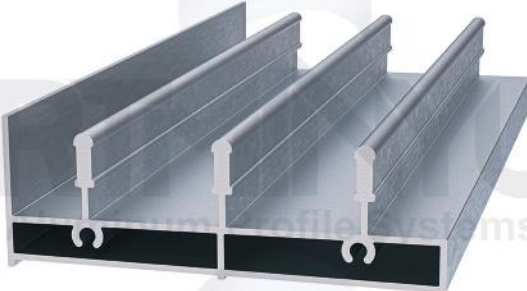

3'lü Alt Baza Profili
3 Pcs Bottom Base Profile

Product Code:2355

Weight kg/m: 1,369
(92,08 x 32,92 x 1,35mm)

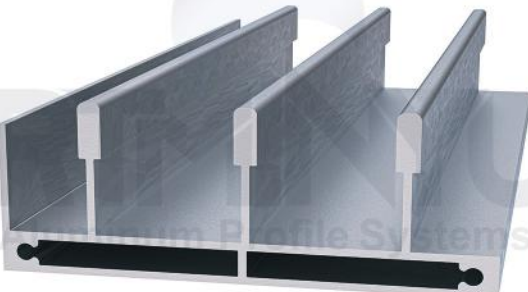

3'lü Üst Baza Profili
3 Pcs Upper Base Profile

Product Code:2469

Weight kg/m: 1,631
(92,8x 30,55 x 1,5mm)



5'li Dikey Baza Profili
5 pcs Vertical Base Profile

Product Code:

Weight kg/m: 1,314
(153,3 x 18 x 1,6mm)



4'lü Dikey Baza Profili
4 pcs Vertical Base Profile

Product Code: 2376

Weight kg/m: 1,266
(122,85 x 20,46 x 1,7mm)



3'lü Dikey Baza Profili
3 pcs Vertical Base Profile

Product Code: 2357

Weight kg/m: 0,962
(93,6 x 20,46 x 1,35mm)

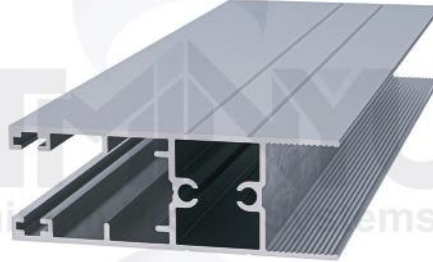

Isı Camlı Alt/Üst Baza Profili
Upper/Lower Base Profile
with Thermal Glass
Product Code: 2356

Weight kg/m: 0,764
(69,5 x 23,1 x 1,2mm)



Çift Kulplu Profil
Double Handle Profile

Product Code: 3215

Weight kg/m: 0,848
(53,1 x 63,11 x 1,45mm)



Tek Kulplu Profil
Single Handle Profile

Product Code: 3216

Weight kg/m: 0,702
(53,1 x 43,6 x 1,45mm)



PETRA 3'lü ISI CAMLI SÜRME SİSTEMİ AKSESUAR TAKIMI / PETRA 3-PIECE HEAT GLASS SLIDING SYSTEM ACCESSORY SET



Kulplu Tapa Plastiği (Alt/Üst)
Plastic Plug with Handle (Top/Bottom)

Code:SRM-30-1

Quantity: 4



Kulplu Alt/Üst Plastik Takoz
Upper/Lower Plastic Wedge with Handles

Code:SRM-30-2

Quantity: 4

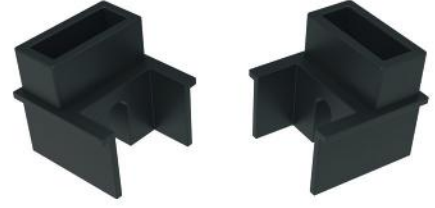

Yan Baza Plastiği Üst Takozu
Side Base Plastic Top Wedge

Code:SRM-30-3

Quantity: 2



Yan Baza Plastiği Alt Takozu
Side Base Plastic Bottom Wedge

Code:SRM-30-4

Quantity: 2



3'lü Üst Köşe Takozu
3-piece Upper Corner Wedge

Code:SRM-30-5

Quantity: 2



3'lü Alt Köşe Takozu
3-piece Bottom Corner Wedge

Code:SRM-30-6

Quantity: 2



Üst Tozluk
Top Leggings

Code:SRM-30-7

Quantity: 2



Alt Tozluk
Bottom Leggings

Code:SRM-30-8

Quantity: 2



Kanat Klavuz Plastiği
Wing Guide Plastic

Code:SRM-30-9

Quantity: 12



4,8X32 Havşa Başlı Akıllı Vida
4.8X32 Countersunk Head Smart Screw

Code:SRM-40

Quantity: 10



Sürme Teker (Yeşil)
Sliding Wheel (Green)

Code:SRM-21

Quantity: 6



3,9x16 Top Başlı Akıllı Vida
3.9x16 Ball Head Smart Screw

Code:SRM-39

Quantity: 58



PETRA 4'lü ISI CAMLI SÜRME SİSTEMİ AKSESUAR TAKIMI / PETRA 4-PIECE HEAT GLASS SLIDING SYSTEM ACCESSORY SET



Kulplu Tapa Plastiği (Alt/Üst)
Plastic Plug with Handle (Top/Bottom)

Code:SRM-31-1

Quantity: 4



Kulplu Alt/Üst Plastik Takoz
Upper/Lower Plastic Wedge with Handles

Code:SRM-31-2

Quantity: 4

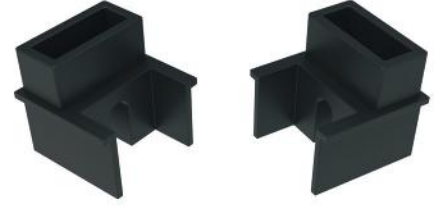

Yan Baza Plastiği Üst Takozu
Side Base Plastic Top Wedge

Code:SRM-31-3

Quantity: 2



Yan Baza Plastiği Alt Takozu
Side Base Plastic Bottom Wedge

Code:SRM-31-4

Quantity: 2



4'lü Üst Köşe Takozu
4-piece Upper Corner Wedge

Code:SRM-31-5

Quantity: 2



4'lü Alt Köşe Takozu
4-piece Bottom Corner Wedge

Code:SRM-31-6

Quantity: 2



Üst Tozluk
Top Leggings

Code:SRM-31-7

Quantity: 3



Alt Tozluk
Bottom Leggings

Code:SRM-31-8

Quantity: 3



Kanat Klavuz Plastiği
Wing Guide Plastic

Code:SRM-31-9

Quantity: 16



4,8X32 Havşa Başlı Akıllı Vida
4.8X32 Countersunk Head

Code:SRM-40

Quantity: 10



Sürme Teker (Yeşil)
Sliding Wheel (Green)

Code:SRM-21

Quantity: 8



3,9X16 Top Başlı Akıllı Vida
3.9X16 Ball Head Smart Screw

Code:SRM-39

Quantity: 70



PETRA 5'İİ ISI CAMLI SÜRME SİSTEMİ AKSESUAR TAKIMI / PETRA 5-PIECE HEAT GLASS SLIDING SYSTEM ACCESSORY SET



Kulplu Tapa Plastiği (Alt/Üst)
Plastic Plug with Handle (Top/Bottom)

Code:SRM-32-1

Quantity: 4



Kulplu Alt/Üst Plastik Takoz
Upper/Lower Plastic Wedge with Handles

Code: SRM-32-2

Quantity: 4

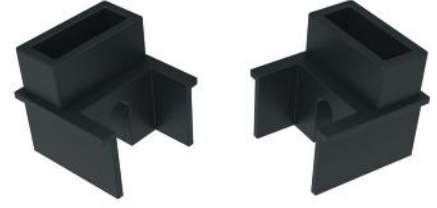

Yan Baza Plastiği Üst Takozu
Side Base Plastic Top Wedge

Code: SRM-32-3

Quantity: 2



Yan Baza Plastiği Alt Takozu
Side Base Plastic Bottom Wedge

Code:SRM-32-4

Quantity: 2



5'li Üst Köşe Takozu
5-piece Upper Corner Wedge

Code:SRM-32-5

Quantity: 2



5'li Alt Köşe Takozu
5-piece Bottom Corner Wedge

Code:SRM-32-6

Quantity: 2



Üst Tozluk
Top Leggings

Code:SRM-32-7

Quantity: 4



Alt Tozluk
Bottom Leggings

Code: SRM-32-8

Quantity: 4



Kanat Klavuz Plastiği
Wing Guide Plastic

Code:SRM-32-9

Quantity: 20



4,8X32 Havşa Başlı Akıllı Vida
4.8X32 Countersunk Head Smart Screw

Code:SRM-40

Quantity: 10



Sürme Teker (Yeşil)
Sliding Wheel (Green)

Code: SRM-21

Quantity: 10



3,9X16 Top Başlı Akıllı Vida
3.9X16 Ball Head Smart Screw

Code:SRM-39

Quantity: 82



6.7-550Kıl Fitol
6.7-550 Bristle Wick

Code:SRM-14

Quantity:



Petra Köşe Alt&Üst Birleşim Plastiği
Petra Corner Top & Bottom Joint Plastic

Code:SRM-33

Quantity:



Düz Kilit
Flat Lock

Code:SRM-34

Quantity:



Yaylı Kilit
Spring Lock

Code:SRM-35

Quantity:



Gagalı Kilit
Beak Lock

Code:Tuba-4

Quantity:

KASA MONTAJI
CASE ASSEMBLY

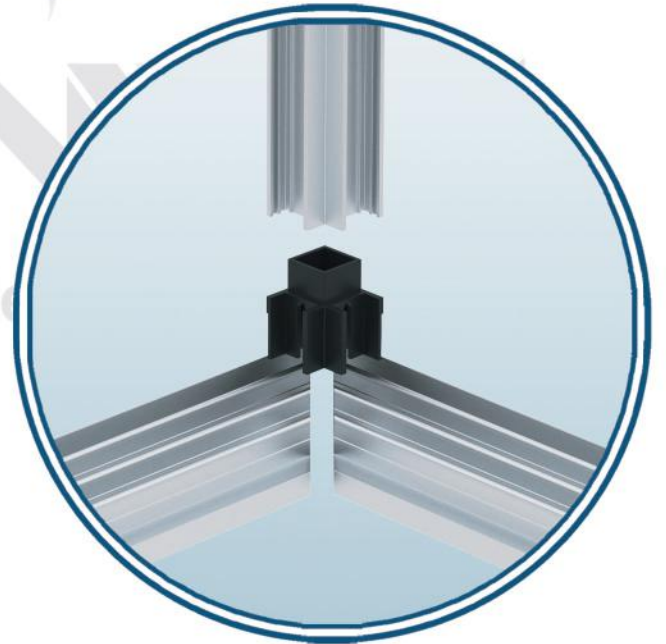
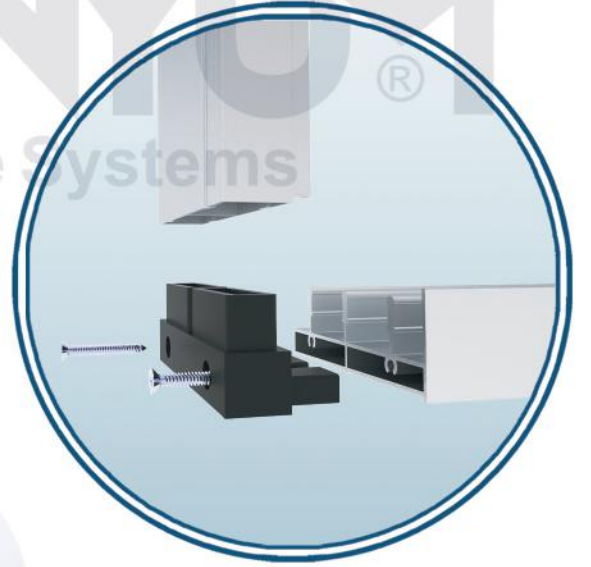
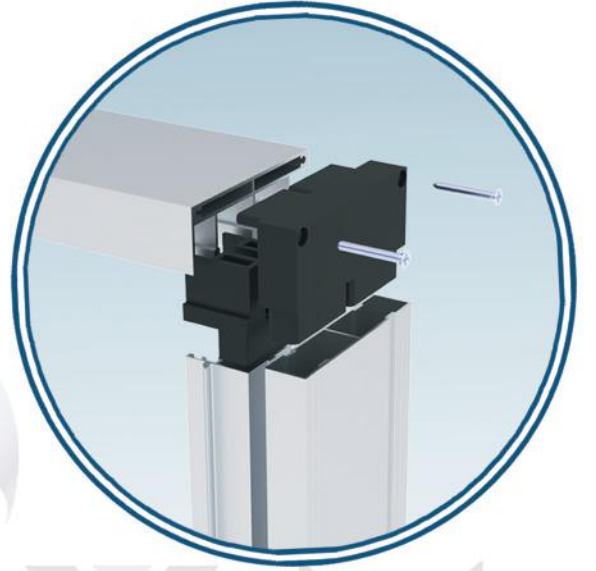

Isı Camlı 3'lü Sürme Sistem Montaj Şeması
Heat Glazed 3 Sliding Systems Assembly Diagram

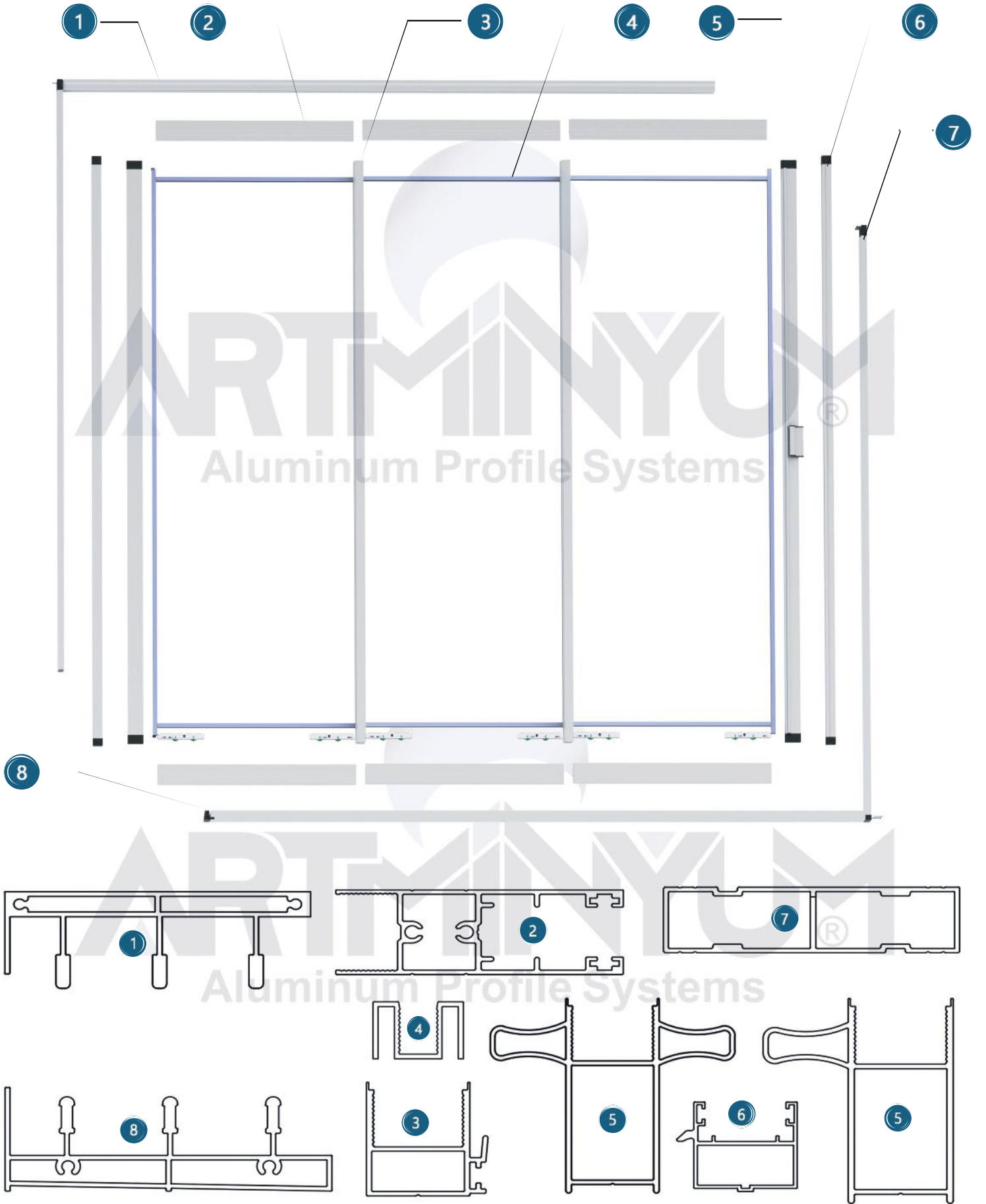

Isı Camlı 3'lü Sürme Sistem Montaj Şeması
Heat Glazed 3 Sliding Systems Assembly Diagram

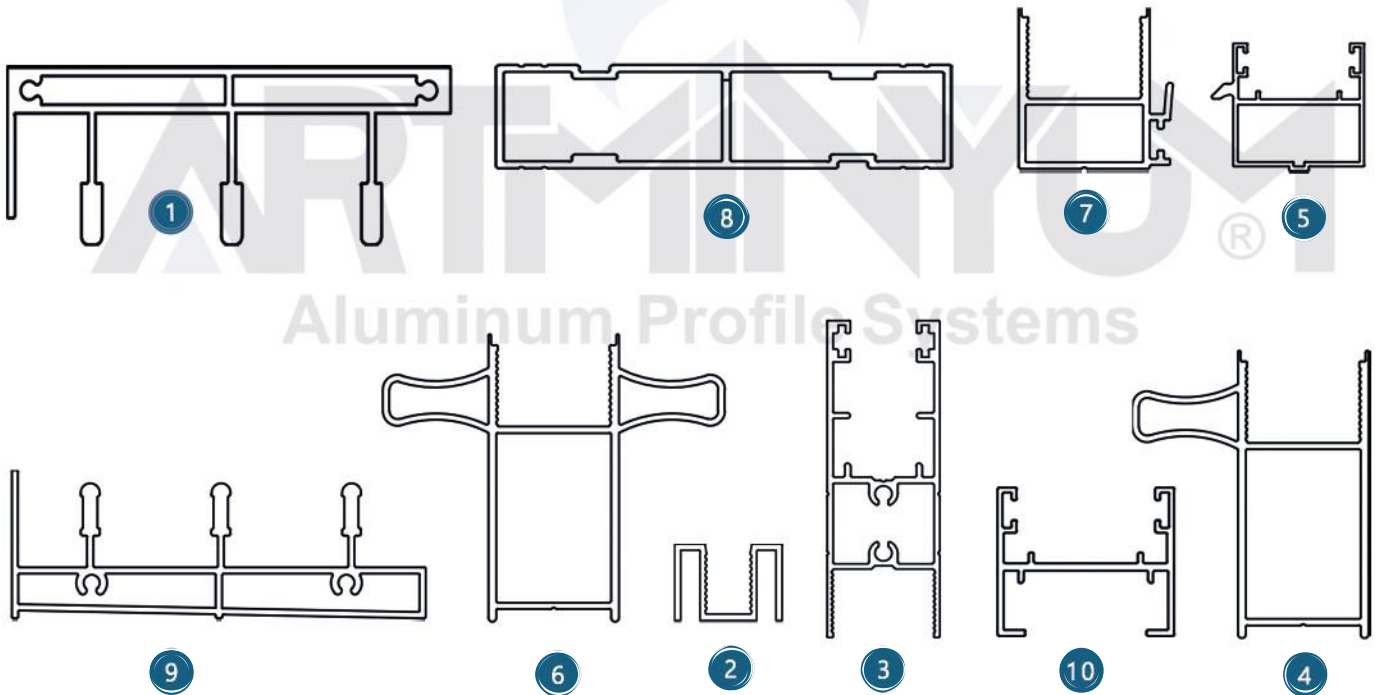
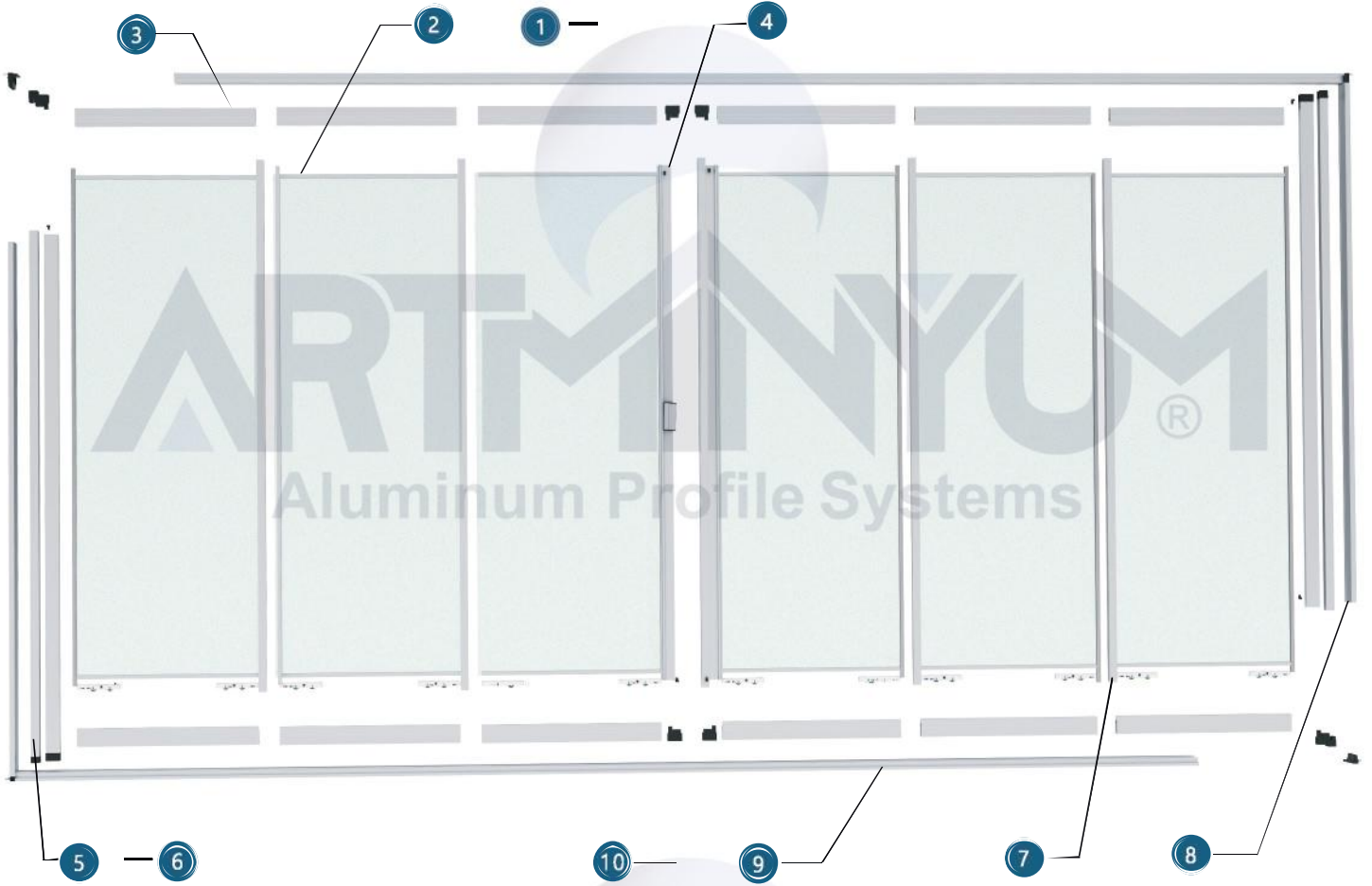

SİSTEM PROFİL KONUMLARI
SYSTEM PROFILE LOCATIONS

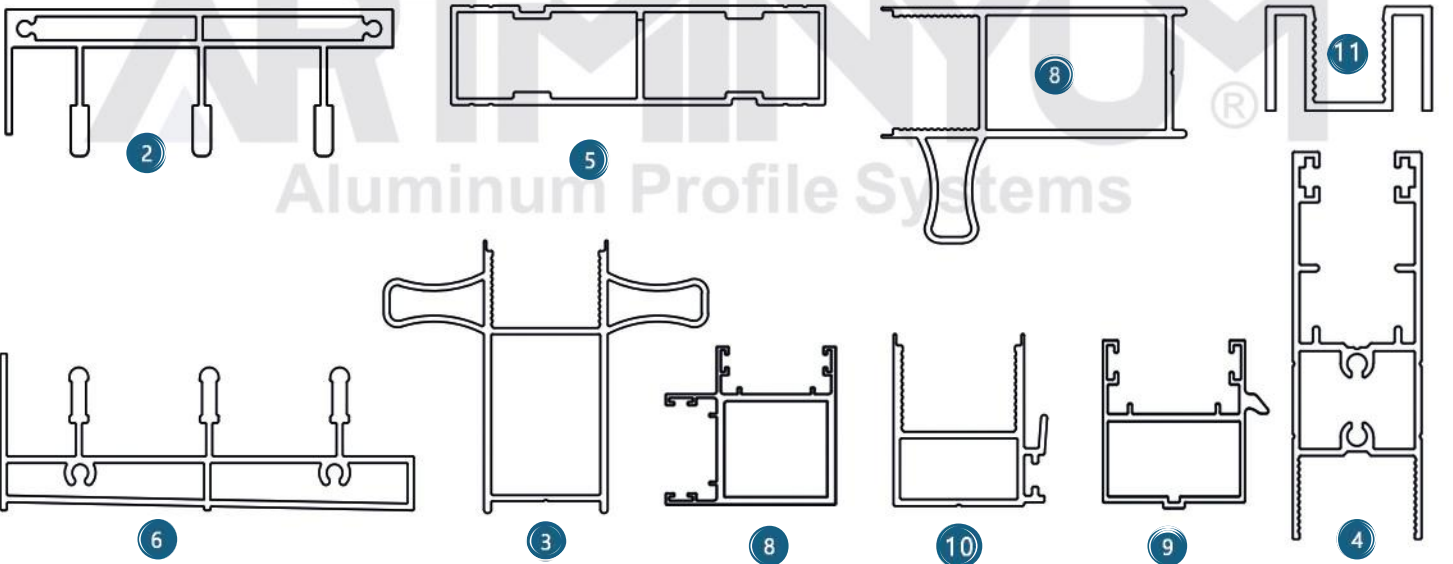
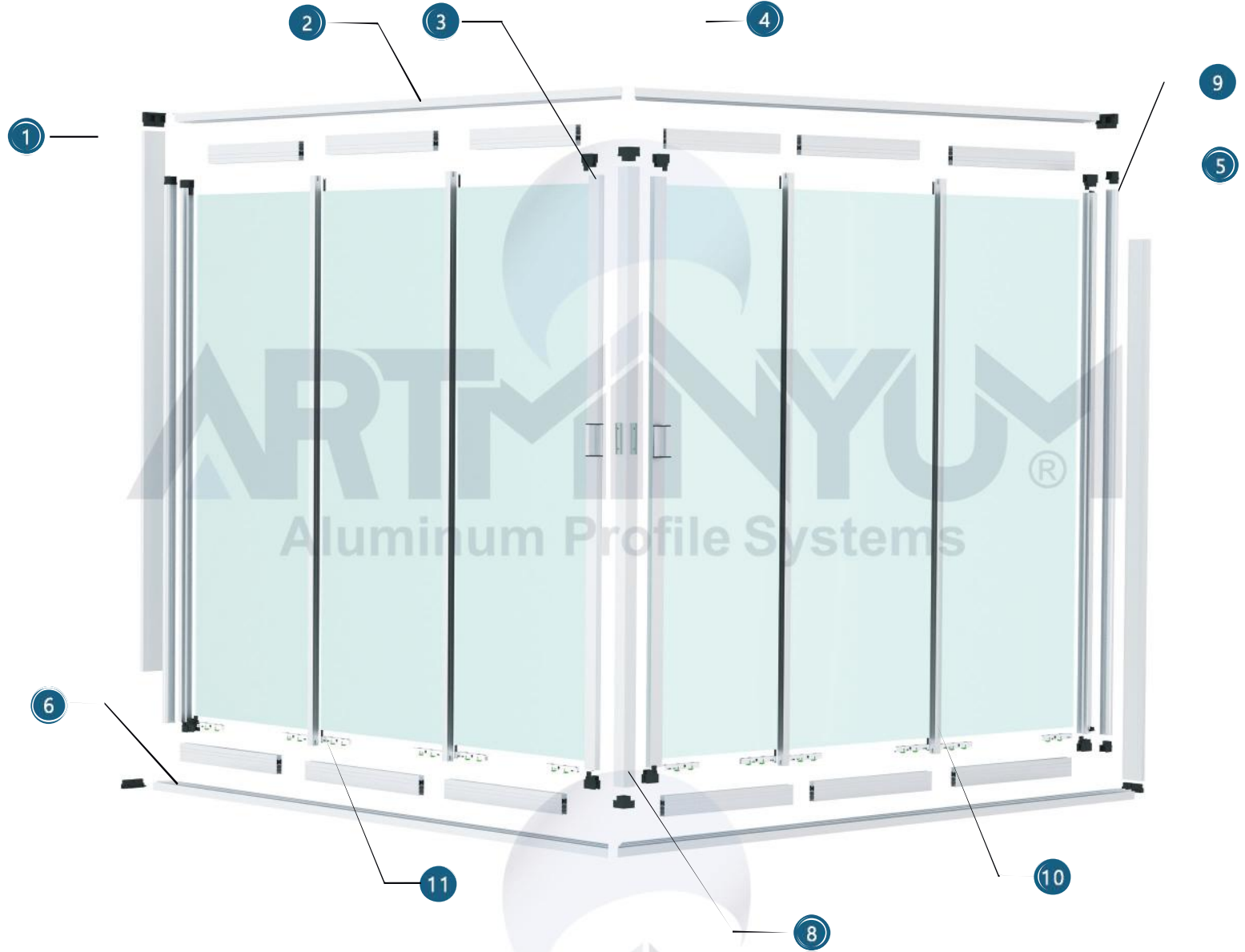

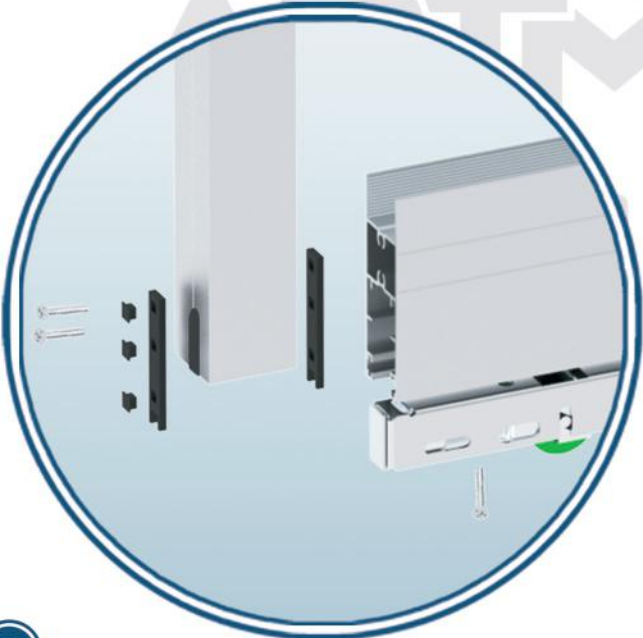
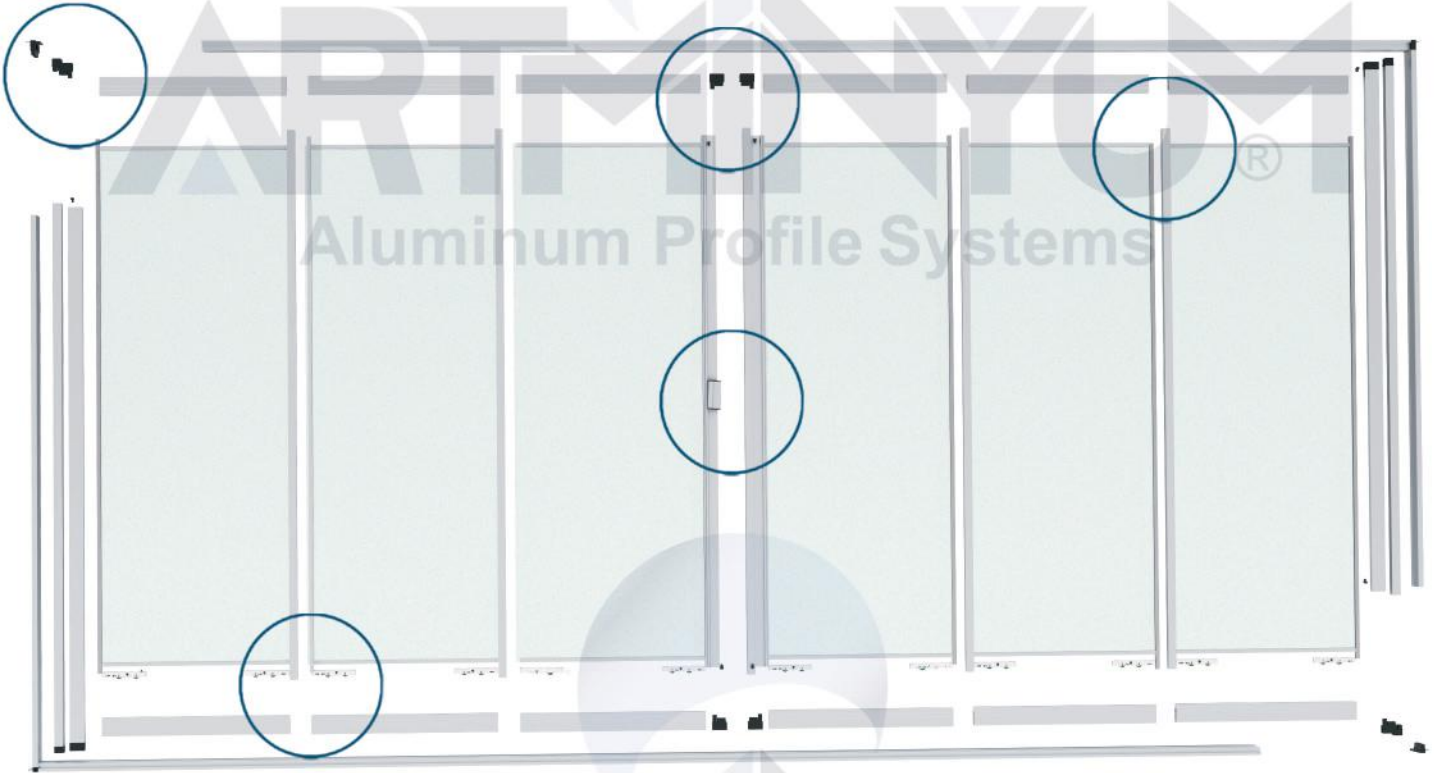
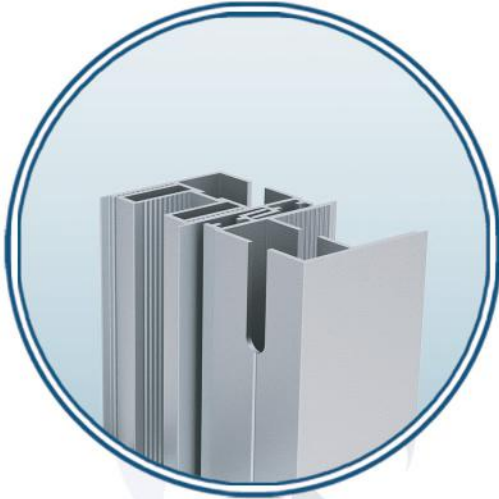

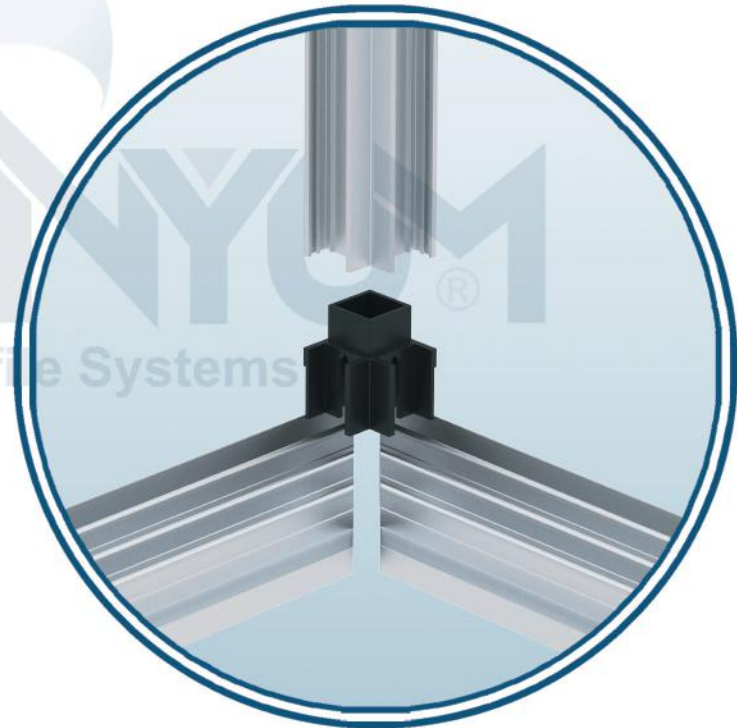
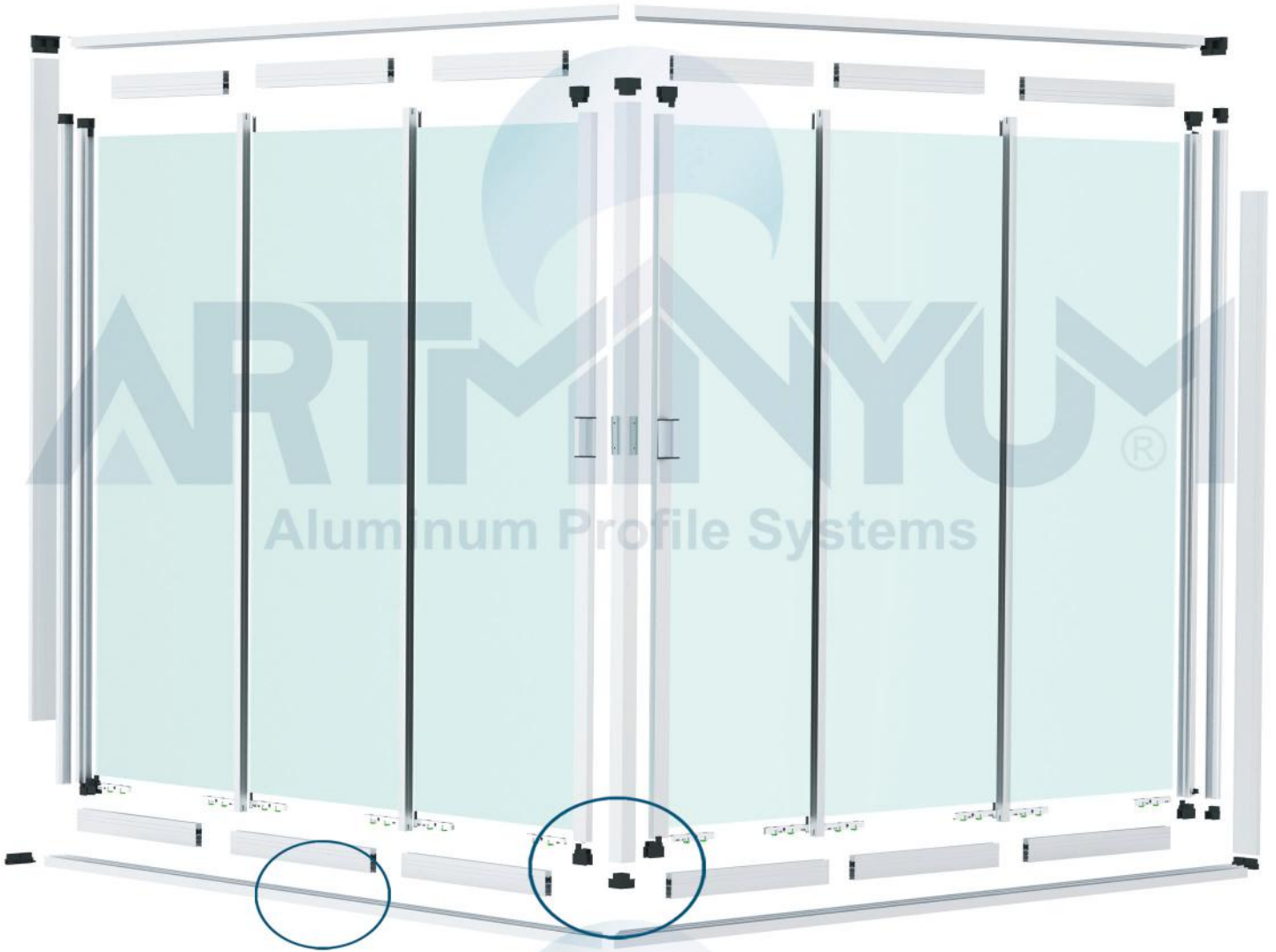



KENAN METAL

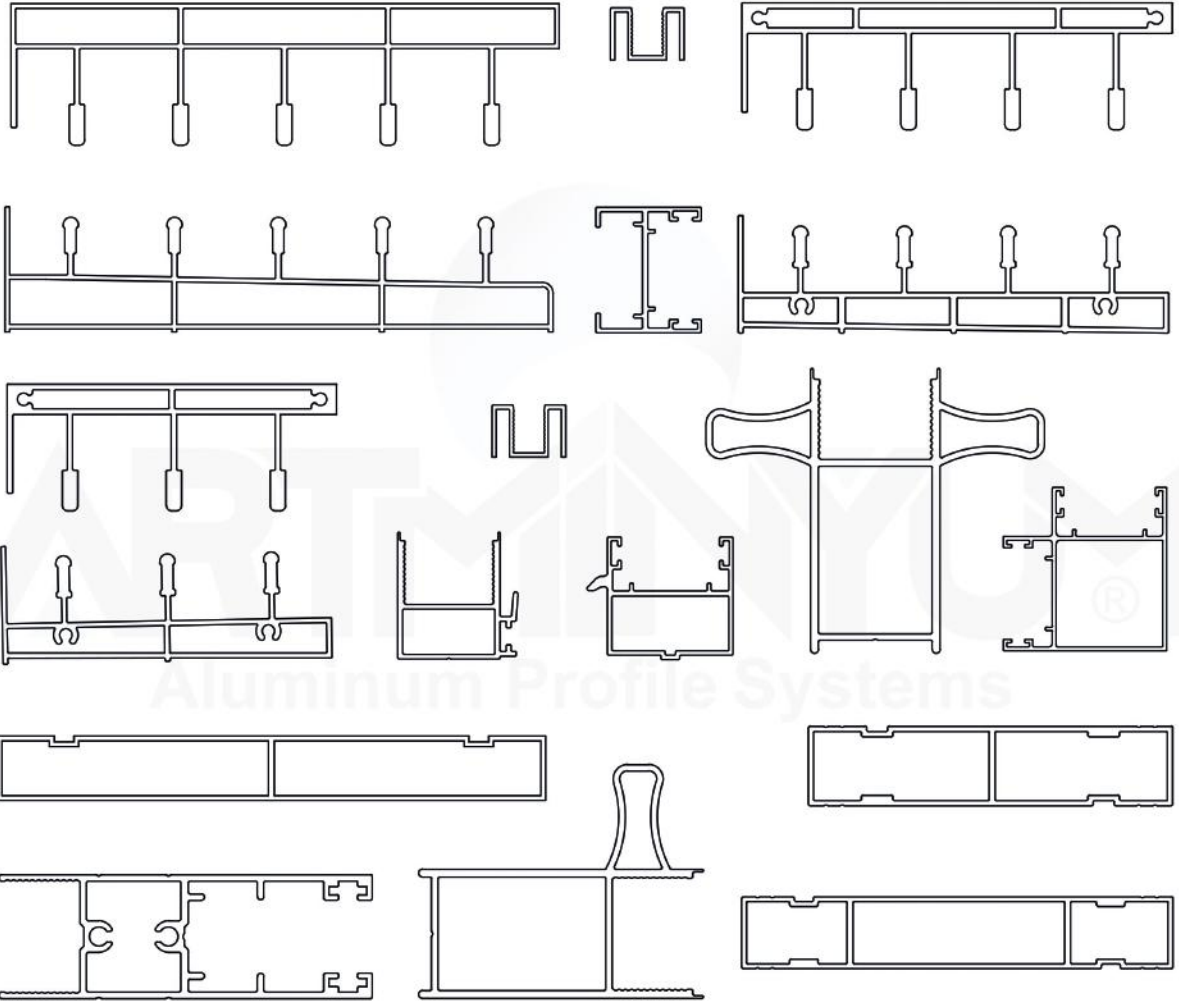

KENAN METAL ALÜMİNYUM PROFİL SAN. TİC. LTD. ŞTİ.



Merkez: Atatürk Bulvarı Mahmut Torun Plaza No:54
Dış Kapı No: 2/7 **İç Kapı No:**2 Başakşehir / İSTANBUL
Tel: +90 212 485 60 35 **Fax:** +90 212 485 60 46
Fabrika: Velimeşe Mah. Kandil Cad. 329 Sk. No:7 Ergene / Tekirdağ

info@kenanmetal.com - www.kenanmetal.com