



KENAN METAL®



Alüminyum Profil Katalođu
Aluminum Profile Catalogue



KENAN METAL®



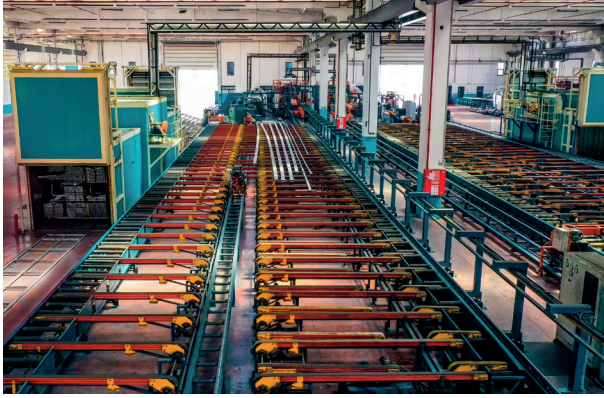

Biz Kimiz ?

Üstün kaliteli alüminyum profil üretimini her geçen gün artan standartlarla devam ettiren Kenan Metal A.Ş. ülkemizin önde gelen alüminyum fabrikalarından biridir. Mutlak müşteri ve çalışan memnuniyeti prensibiyle üretim yapan Kenan Metal A.Ş., tente pergola, inşaat ve özel profiller gibi farklı sektörlerin mevcut ve gelecekteki beklentilerini karşılayan, çevreyle dost üretim sistemlerini benimseyen, küresel etkileşimleri yakından takip ederek sürekli yenilenen, çağdaş bir vizyonla gelişiyor. Ürün-kalite çıtasının sürekli yükseltilmesi, ürün yelpazesinin geliştirilmesi, yeni ürünlerin tasarımı, kullanım alanlarının artırılması için sürekli olarak çalışan Ar-Ge bölümüyle göz dolduran Kenan Metal A.Ş., kalitesi güvenilirliği, kullandığı teknoloji ve özel çözümler üretme gücüyle pazar payını sürekli genişletiyor.

Kenan Metal A.Ş., alüminyum bazlı ürünlerin kalitelerini artırarak ve kullanım alanlarını yaygınlaştırarak doğal ve estetik mekanların yaratılmasına da öncülük ediyor. Her yapı için kendine özgü üstün nitelikli ve ileri teknoloji gerektiren çağdaş çözümler sunan Kenan Metal A.Ş., esnek yaklaşımları üstün hizmet kalitesi ve fiyat-kalite dengesiyle küresel pazarda söz sahibi bir kurum olma yolunda emin adımlarla ilerliyor.

Who Are We?

Kenan Metal is one of the leading aluminum factories of our country which continues to produce high quality aluminum profiles with increasing standards each passing day. Kenan Metal which makes production with absolute customer and employee satisfaction principle, develops with a modern vision that meets current and future expectations of different sectors such as awning pergola, construction and special profiles, adopts environmentally friendly production systems, renews itself constantly by following global interactions closely.

Kenan Metal which makes a strong impression with its R&D department working constantly for raising product-quality level, improving product range, designing new products, increasing usage areas, expands its market share constantly with its quality, credibility technology used and power to produce special solutions

Kenan Metal is also leading creation of natural and aesthetic spaces by increasing quality of aluminum-based products and expanding usage areas. Kenan Metal which offers its unique, superior and modern solutions requiring advanced technology for every structure, is moving confidently on its way to become a promising company in global market with its flexible approaches, superior service quality and price-quality balance.

■ **KENAN METAL STANDART PROFİLLER / KENAN METAL STANDART PROFILES**

Dikey Profiller / Vertical Curtain System	9
Aldoks Kapı ve Pencere Profilleri / Aldoks Door and Window Profiles	10 - 11
C60 Kapı ve Pencere Profilleri / C60 Door and Window Profiles	12 - 13
Doğrama Profilleri / Joinery Profiles	14 - 21
Boru Profilleri / Tube Profiles	22 - 27
Menteşe Profilleri / Hinge Profiles	28 - 31
Kulp Profilleri / Handle Profiles	32 - 35
Sineklik Profilleri / Mosquito Net Profiles	36 - 37
Aydınlatma Profilleri / Lighting Profiles	38 - 47
Soğutma Profilleri / Cooling Profiles	48 - 49
Küpeşte Profilleri / Handrail Profiles	50 - 51
Menfez Profilleri / Air Went Profiles	52 - 53
Cephe Profilleri / Facade Profiles	54 - 57
Solar Profiller / Solar Profiles	58 - 61
Kepen ve Panjur Profilleri / Shutter Profiles	62 - 71
Fotoselli Kapı Profilleri / Photocell Door Profiles	72 - 73

■ **TENTE PROFİLLERİ / AWNING PROFILES**

Kasetli Tente Profilleri / Cassette Awning Profiles	75 - 77
Pencere Kasetli Tente Profilleri / Window Cassette Awning Profiles	78 - 79
Mafsallı Tente Profilleri / Articulated Awning Profiles	80 - 83

■ PERGOLA SİSTEMLERİ / PERGOLA SYSTEMS

Eğimli ve Oval Pergola Sistemleri / Inclined and Curved Pergola Systems

86 - 93

■ BİOKLİMATİK SİSTEMLERİ / BIOCLIMATIC SYSTEMS

Bio Per Bioklimatik / Bio Per Bioclimatic

94 - 97

Palmera Bioklimatik / Palmera Bioclimatic

98 - 101

Lavin Bioklimatik / Lavin Bioclimatic

102 - 105

Cabana Bioklimatik / Cabana Bioclimatic

106 - 107

■ ROLLING ROOF SİSTEMLERİ / ROLLING ROOF SYSTEMS

Rolling Roof Profilleri / Rolling Roof Systems

108 - 111

■ HAREKETLİ VE SABİT CAM TAVAN SİSTEMLERİ / MOVABLE AND FIXED GLASS ROOF SYSTEMS

Veranda Sistemleri / Veranda Systems

112 - 117

Sürgülü Cam Çatı Sistemleri / Movable Glass Roof Systems

118 - 121

Küp Veranda Sistemleri / Cube Veranda Systems

122 - 125

■ CAM SİSTEMLERİ / GLASS SYSTEMS

Modena Sürme Sistemleri / Modena Sliding Systems

126 - 129

Giyotin Cam Sistemleri / Guillotine Glass Systems

130 - 133

Isı Camlı Sürme Sistemleri / Double Glass Sliding Systems

134 - 137

Katlanır Cam Sistemleri / Folding Glass Systems

138 - 141

Tuba Çift Sürme Sistemleri / Tuba Double Glass Sliding Systems

142 - 145

Petra Çift Sürme Sistemleri / Petra Double Glass Sliding Systems

146 - 149

Lotus Giyotin Cam Sistemleri / Lotus Guillotine Glass Systems

150 - 153

■ ZİP PERDE SİSTEMLERİ / ZIP CURTAIN SYSTEMS

Dikey Perde Sistemleri / Vertical Curtain Systems

154 - 155

Yatay Perde Sistemleri / Horizontal Curtain Systems

156 - 157

■ BAHÇE ÇİTİ VE RÜZGAR KIRICI SİSTEMLERİ / GARDEN FENCE AND WINDBRAKER SYSTEMS

Bahçe Çiti Sistemleri / Garden Fence Systems

158 - 163

Rüzgar Kırıcı Sistemleri / Windbraker Systems

164 - 165



We produce
high quality aluminum profiles
with superior technology

SQR CERTIFICATION

Sertifika
CERTIFICATE

KENAN METAL A.Ş.

MERKEZ: İTİTİLLİ ORGANİZE SANAYİ BÖLGESİ ATAÜRK BEYLARI LO.8.8 SİTESİ İYERİ
BLOK NO: 547 BAŞAKSİHİRİSTABUL ÜRÜNLERİ
SÜRE YELİNEK MAHALLESİ KANDIL SOKAK NO:7 ERGENE TEKİRDAĞ ÜRÜNLERİ

ISO 9001:2015

Kapsam/Scope
ALÜMİNYUM VE ZAMAK KÜÇEC, ALÜMİNYUM KÜTEK (BİLETT) ÜRETİM, ALÜMİNYUM PROFİL FIRIN MAKİNALARININ YEDER PARÇA İMALATI, İTHALATI, İHRACATI VE ALIM SATIMI
ALUMINIUM AND ZAMAK INNOTS, ALUMINIUM BILLET (BILLET) PRODUCTION, SPARE PARTS MANUFACTURING, IMPORT, EXPORT AND PURCHASE OF ALUMINIUM PROFILE OVENS MACHINES

The certificate is valid until the end of the inspection cycle and the expiration date of the inspection cycle is completed successfully.

This is to certify that the above mentioned Company meets the requirements of Quality Management System.

Belge No / Certificate Number : MTS-27664
Başlangıç Tarihi / Date of Issue : 8.12.2022
Süre / Validity / Date of Expiry : 8.12.2022
Geçerlilik Tarihi / Date of Expiry : 7.12.2023

The certificate holder undertakes to inform the customer in a timely manner of any changes to the certificate.
The certificate is valid until the end of the inspection cycle and the expiration date of the inspection cycle is completed successfully.

IAF IAS
sigma cert
Genel Müdür / General Manager

SQR CERTIFICATION

Sertifika
CERTIFICATE

KENAN METAL A.Ş.

MERKEZ: İTİTİLLİ ORGANİZE SANAYİ BÖLGESİ ATAÜRK BEYLARI LO.8.8 SİTESİ İYERİ
BLOK NO: 547 BAŞAKSİHİRİSTABUL ÜRÜNLERİ
SÜRE YELİNEK MAHALLESİ KANDIL SOKAK NO:7 ERGENE TEKİRDAĞ ÜRÜNLERİ

ISO 10002:2018

Kapsam/Scope
ALÜMİNYUM VE ZAMAK KÜÇEC, ALÜMİNYUM KÜTEK (BİLETT) ÜRETİM, ALÜMİNYUM PROFİL FIRIN MAKİNALARININ YEDER PARÇA İMALATI, İTHALATI, İHRACATI VE ALIM SATIMI
ALUMINIUM AND ZAMAK INNOTS, ALUMINIUM BILLET (BILLET) PRODUCTION, SPARE PARTS MANUFACTURING, IMPORT, EXPORT AND PURCHASE OF ALUMINIUM PROFILE OVENS MACHINES

The certificate is valid until the end of the inspection cycle and the expiration date of the inspection cycle is completed successfully.

This is to certify that the above mentioned Company meets the requirements of Customer Satisfaction Management System.

Belge No / Certificate Number : MTS-27667
Başlangıç Tarihi / Date of Issue : 8.12.2022
Süre / Validity / Date of Expiry : 8.12.2022
Geçerlilik Tarihi / Date of Expiry : 7.12.2023

The certificate holder undertakes to inform the customer in a timely manner of any changes to the certificate.
The certificate is valid until the end of the inspection cycle and the expiration date of the inspection cycle is completed successfully.

IAF IAS
sigma cert
Genel Müdür / General Manager

SQR CERTIFICATION

Sertifika
CERTIFICATE

KENAN METAL A.Ş.

MERKEZ: İTİTİLLİ ORGANİZE SANAYİ BÖLGESİ ATAÜRK BEYLARI LO.8.8 SİTESİ İYERİ BLOK
NO: 547 BAŞAKSİHİRİSTABUL ÜRÜNLERİ
SÜRE YELİNEK MAHALLESİ KANDIL SOKAK NO:7 ERGENE TEKİRDAĞ ÜRÜNLERİ

ISO 14001:2015

Kapsam/Scope
ALÜMİNYUM VE ZAMAK KÜÇEC, ALÜMİNYUM KÜTEK (BİLETT) ÜRETİM, ALÜMİNYUM PROFİL FIRIN MAKİNALARININ YEDER PARÇA İMALATI, İTHALATI, İHRACATI VE ALIM SATIMI
ALUMINIUM AND ZAMAK INNOTS, ALUMINIUM BILLET (BILLET) PRODUCTION, SPARE PARTS MANUFACTURING, IMPORT, EXPORT AND PURCHASE OF ALUMINIUM PROFILE OVENS MACHINES

The certificate is valid until the end of the inspection cycle and the expiration date of the inspection cycle is completed successfully.

This is to certify that the above mentioned Company meets the requirements of Environmental Management System.

Belge No / Certificate Number : MTS-27665
Başlangıç Tarihi / Date of Issue : 8.12.2022
Süre / Validity / Date of Expiry : 8.12.2022
Geçerlilik Tarihi / Date of Expiry : 7.12.2023

The certificate holder undertakes to inform the customer in a timely manner of any changes to the certificate.
The certificate is valid until the end of the inspection cycle and the expiration date of the inspection cycle is completed successfully.

IAF IAS
sigma cert
Genel Müdür / General Manager

SQR CERTIFICATION

Sertifika
CERTIFICATE

KENAN METAL A.Ş.

MERKEZ: İTİTİLLİ ORGANİZE SANAYİ BÖLGESİ ATAÜRK BEYLARI LO.8.8 SİTESİ İYERİ
BLOK NO: 547 BAŞAKSİHİRİSTABUL ÜRÜNLERİ
SÜRE YELİNEK MAHALLESİ KANDIL SOKAK NO:7 ERGENE TEKİRDAĞ ÜRÜNLERİ

ISO 45001:2018

Kapsam/Scope
ALÜMİNYUM VE ZAMAK KÜÇEC, ALÜMİNYUM KÜTEK (BİLETT) ÜRETİM, ALÜMİNYUM PROFİL FIRIN MAKİNALARININ YEDER PARÇA İMALATI, İTHALATI, İHRACATI VE ALIM SATIMI
ALUMINIUM AND ZAMAK INNOTS, ALUMINIUM BILLET (BILLET) PRODUCTION, SPARE PARTS MANUFACTURING, IMPORT, EXPORT AND PURCHASE OF ALUMINIUM PROFILE OVENS MACHINES

The certificate is valid until the end of the inspection cycle and the expiration date of the inspection cycle is completed successfully.

This is to certify that the above mentioned Company meets the requirements of Occupational Health & Safety Management System.

Belge No / Certificate Number : MTS-27666
Başlangıç Tarihi / Date of Issue : 8.12.2022
Süre / Validity / Date of Expiry : 8.12.2022
Geçerlilik Tarihi / Date of Expiry : 7.12.2023

The certificate holder undertakes to inform the customer in a timely manner of any changes to the certificate.
The certificate is valid until the end of the inspection cycle and the expiration date of the inspection cycle is completed successfully.

IAF IAS
sigma cert
Genel Müdür / General Manager

CERTIFICATE
for a COATING APPLICATOR

QUALICOAT

herby authorities

KENAN METAL ANONİM ŞİRKETİ
Volimeşe Mahallesi Kandil Sokak No:7
Ergene
59880 TEKİRDAĞ
Turkey

to use the quality label in conformity with the QUALICOAT 2023 Specifications, applicable from 1 January 2023

Licence No.: 1465
Date of Granting: 22.06.2022
Valid until: 31.12.2023

Zürich, 1 January 2023

QUALICOAT
Jvo Vermeeren
President

Pascal Bellet
Secretary General

QUALICOAT | Tössstrasse 48, 8002 Zürich, Switzerland | www.qualicoat.net

UNIVERSAL
CERTIFICATION

FABRİKA ÜRETİM KONTROLÜ
Uygunluk Belgesi

Belge No: 2163 - CPR - 0960

Avrupa Parlamentosu'nun Komisyon'unun 9 Mart 2011 tarih ve 305/2011/EK sayılı Tebliği (Yapı Malzemeleri Ürünleri) (CPD) sistemine, bu belge aşağıdaki belirlenen yapı malzemesine uygulanır.

KENAN METAL ANONİM ŞİRKETİ
İtaliye Organize Sanayi Bölgesi Malhaneli Anadolı Bulvarı LO.8.8 Sitesi İyeri Blok No: 547 İ. Kapı No:2 Başakşehir / İSTANBUL

İsimden tarifiyle
Volimeşe Organize Sanayi Bölgesi Malhaneli 248. Sokak No:10 Ergene / TEKİRDAĞ
Aleviaski'deki fabrikasında üretilen ve pazarla satılan
ALÜMİNYUM ALAŞIMLARINDAN EXTRÜZEDİLERİ PROFİL MAMÜL KALİTESİ: EN AW 6066 EN AW 6063 (TEMPER DURUMU: T5, T6)

Tamamı üretimi kontrol eden belgenin ipi donatılacak olan üretilen ve fabrika üretim kontrolü olacaktır.

EN 15088:2005
Bu belge, EN standardı 1502:2002 belgenin altıncı bölümüne göre uygulanmaktadır. Yapı Malzemeleri, PEDD yönetmeliği ya da diğer teknikteki imalat koşulları ile ilgili değişiklikler söz konusu olduğunda, Üretim Kontrolü, Üretim Kontrolü Belgesi'ne Katılım Kararları ile ilgili olarak ayrıca alınan veya özel olarak 1402/2023 tarihli karar gerektirir.

İSTANBUL - 14/10/2022

Süre KACMAZ
UNIVERSAL CERTIFICATION
Yürütme Kurulu Başkanı

UNIVERSALCERT.COM

UNIVERSAL
CERTIFICATION

FACTORY PRODUCTION CONTROL
Certificate Of Conformity (System 2+)

Certificate Number: 2163 - CPR - 0960

This certificate is implemented in the construction product mentioned below according to European Community Council's 9 March 2011 (2011/181) numbered regulation (Construction Products Regulation or CPR) by company

KENAN METAL ANONİM ŞİRKETİ
İtaliye Organize Sanayi Bölgesi Malhaneli Anadolı Bulvarı LO.8.8 Sitesi İyeri Blok No: 547 İ. Kapı No:2 Başakşehir / İSTANBUL

İsimden tarifiyle
Volimeşe Organize Sanayi Bölgesi Malhaneli 248. Sokak No:10 Ergene / TEKİRDAĞ
Aleviaski'deki fabrikasında üretilen ve pazarla satılan
EXTRÜDE PROFİLİ ALUMİNYUM ALAŞIMLARI
PRODUCT QUALITY: EN AW 6066 EN AW 6063 (TEMPER TS, T6)

defined products are submitted by the manufacturer to initial type-testing and the factory production control. With this certificate
EN 15088:2005

All provisions identified at Annex ZA of the Standard related to the assessment and verification of consistency of performance as applied under system 2+ and
Factory Production Control's assessment that shows that it complies with the relevant requirements.

This certificate issued firstly on 15.02.2022 and if not suspended or canceled for any reason by notified factory production control body and harmonized standard, construction product, market shall include or production process at production area are if not changed is valid until 14/02/2023

İSTANBUL - 15/02/2022

Süre KACMAZ
UNIVERSAL CERTIFICATION
Chairman of the Board

UNIVERSALCERT.COM

UNIVERSAL
CERTIFICATION

FACTORY PRODUCTION CONTROL
Certificate Of Conformity (System 2+)

Certificate Number: 2163 - CPR - 960

This certificate is implemented in the construction product mentioned below according to European Community Council's 9 March 2011 (2011/181) numbered regulation (Construction Products Regulation or CPR) by company

KENAN METAL ALÜMİNYUM PROFİL SANAYİ TİCARET LİMİTED ŞİRKETİ
İtaliye Organize Sanayi Bölgesi Malhaneli Anadolı Bulvarı LO.8.8 Sitesi İyeri Blok No: 547 İ. Kapı No:2 Başakşehir / İSTANBUL

İsimden tarifiyle
Volimeşe Organize Sanayi Bölgesi Malhaneli 248. Sokak No:10 Ergene / TEKİRDAĞ
Aleviaski'deki fabrikasında üretilen ve pazarla satılan
ALÜMİNYUM ALAŞIMLARINDAN EXTRÜZEDİLERİ PROFİL MAMÜL KALİTESİ: EN AW 6066 EN AW 6063 (TEMPER DURUMU: T5, T6)

defined products are submitted by the manufacturer to initial type-testing and the factory production control. With this certificate
EN 15088:2005

All provisions identified at Annex ZA of the Standard related to the consistency of performance assessment and confirmation as applied under system 2+ and
Factory Production Control's assessment that shows that it complies with the relevant requirements.

This certificate issued firstly on 15.02.2022 and if not suspended or canceled for any reason by notified factory production control body and harmonized standard, construction product, market shall include or production process at production area are if not changed is valid until 14/02/2023

İSTANBUL - 15.02.2022

Süre KACMAZ
UNIVERSAL CERTIFICATION
Chairman of the Board

UNIVERSALCERT.COM

UNIVERSAL
CERTIFICATION

FABRİKA ÜRETİM KONTROLÜ
Uygunluk Belgesi (Sistem 2+)

Belge No: 2163- CPR- 960

Avrupa Parlamentosu'nun Komisyon'unun 9 Mart 2011 tarih ve 305/2011/EK sayılı Tebliği (Yapı Malzemeleri Ürünleri) (CPD) sistemine, bu belge aşağıdaki belirlenen yapı malzemesine uygulanır.

KENAN METAL ALÜMİNYUM PROFİL SANAYİ TİCARET LİMİTED ŞİRKETİ
İtaliye Organize Sanayi Bölgesi Malhaneli Anadolı Bulvarı LO.8.8 Sitesi İyeri Blok No: 547 İ. Kapı No:2 Başakşehir / İSTANBUL

İsimden tarifiyle
Volimeşe Organize Sanayi Bölgesi Malhaneli 248. Sokak No:10 Ergene / TEKİRDAĞ
Aleviaski'deki fabrikasında üretilen ve pazarla satılan
ALÜMİNYUM ALAŞIMLARINDAN EXTRÜZEDİLERİ PROFİL MAMÜL KALİTESİ: EN AW 6066 EN AW 6063 (TEMPER DURUMU: T5, T6)

Tamamı üretimi kontrol eden belgenin ipi donatılacak olan üretilen ve fabrika üretim kontrolü olacaktır.

EN 15088:2005
Bu belge, EN standardı 1502:2002 belgenin altıncı bölümüne göre uygulanmaktadır. Yapı Malzemeleri, PEDD yönetmeliği ya da diğer teknikteki imalat koşulları ile ilgili değişiklikler söz konusu olduğunda, Üretim Kontrolü, Üretim Kontrolü Belgesi'ne Katılım Kararları ile ilgili olarak ayrıca alınan veya özel olarak 1402/2023 tarihli karar gerektirir.

İSTANBUL - 15.02.2022

Süre KACMAZ
UNIVERSAL CERTIFICATION
Yürütme Kurulu Başkanı

UNIVERSALCERT.COM



KENAN METAL
STANDART PROFILLER
STANDART PROFILES



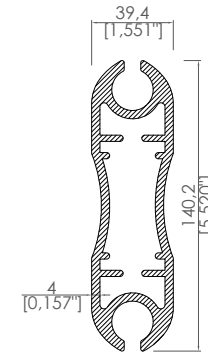
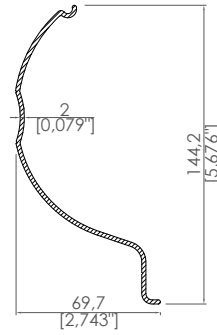
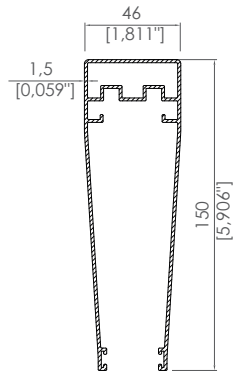

Ürün Kodu / Product Code	5311
Kalınlık / Thickness	1,5 mm
Ağırlık / Weight	1,793 kg/m 3,953 lb/m

Ürün Kodu / Product Code	6336
Kalınlık / Thickness	2 mm
Ağırlık / Weight	1,051 kg/m 2,317 lb/m

Ürün Kodu / Product Code	6335
Kalınlık / Thickness	4 mm
Ağırlık / Weight	1,225 kg/m 2,7007 lb/m

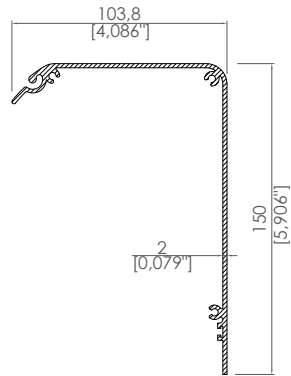

Ürün Kodu / Product Code	6337
Kalınlık / Thickness	2 mm
Ağırlık / Weight	1,691 kg/m 3,728 lb/m

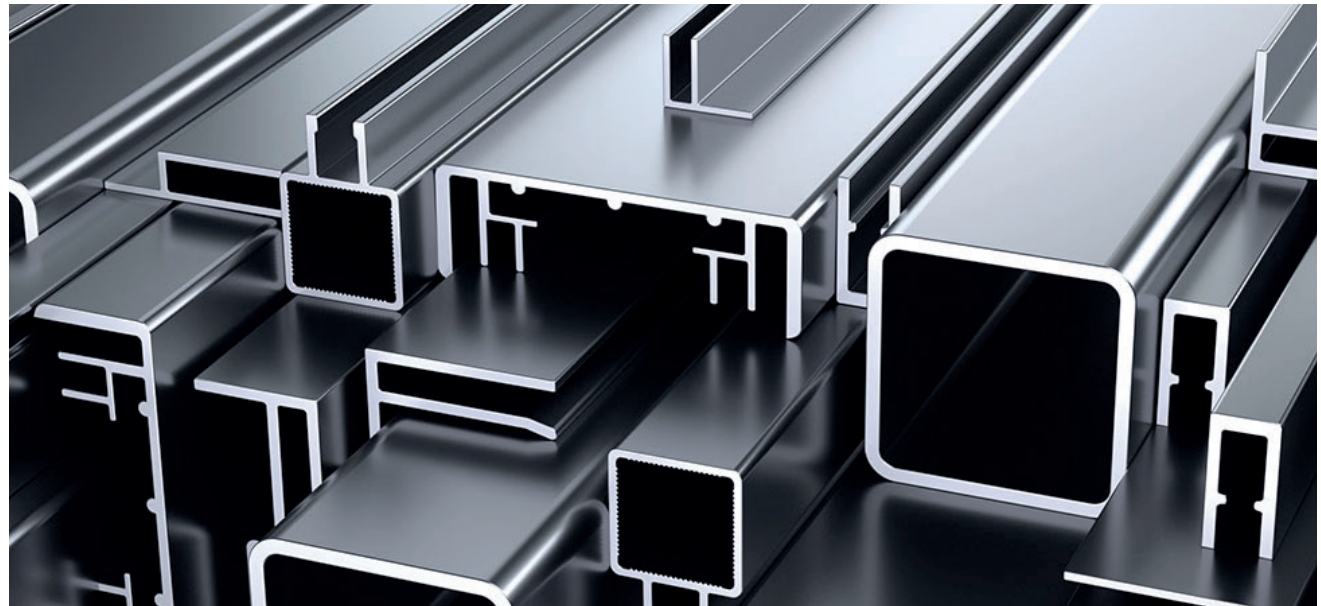

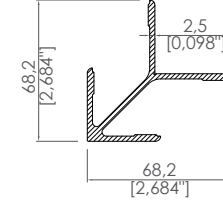

Ürün Kodu / Product Code	2239
Kalınlık / Thickness	2,5 mm
Ağırlık / Weight	1,327 kg/m 2,9255 lb/m

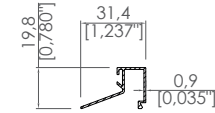
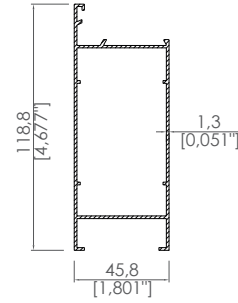
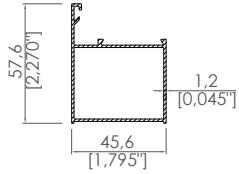

Ürün Kodu / Product Code	2235
Kalınlık / Thickness	1,2 mm
Ağırlık / Weight	0,626 kg/m 1,38 lb/m

Ürün Kodu / Product Code	2238
Kalınlık / Thickness	1,3 mm
Ağırlık / Weight	1,156 kg/m 2,5485 lb/m

Ürün Kodu / Product Code	2241
Kalınlık / Thickness	0,9 mm
Ağırlık / Weight	0,185 kg/m 0,40786 lb/m

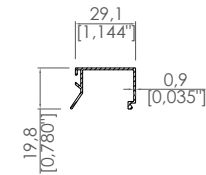
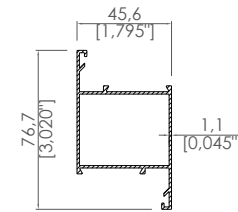
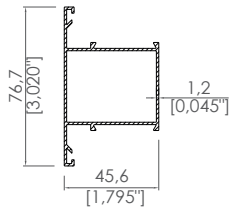

Ürün Kodu / Product Code	2236
Kalınlık / Thickness	1,2 mm
Ağırlık / Weight	0,741 kg/m 1,6336 lb/m

Ürün Kodu / Product Code	2237
Kalınlık / Thickness	1,1 mm
Ağırlık / Weight	0,741 kg/m 1,6336 lb/m

Ürün Kodu / Product Code	2240
Kalınlık / Thickness	0,9 mm
Ağırlık / Weight	0,192 kg/m 0,4233 lb/m

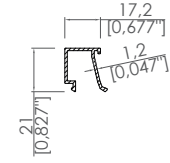

Ürün Kodu / Product Code	2226
Kalınlık / Thickness	1,2 mm
Ağırlık / Weight	0,211 kg/m 0,4652 lb/m

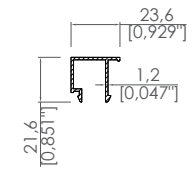

Ürün Kodu / Product Code	2227
Kalınlık / Thickness	1,2 mm
Ağırlık / Weight	0,237 kg/m 0,5225 lb/m

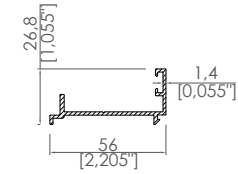
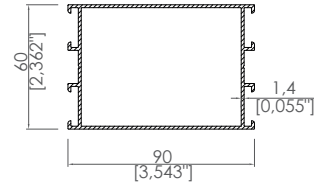
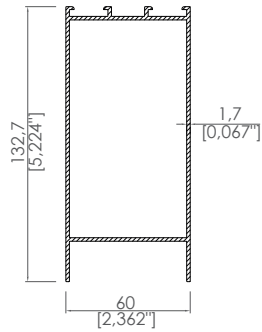

Ürün Kodu / Product Code	2220
Kalınlık / Thickness	1,7 mm
Ağırlık / Weight	1,818kg/m 4,008 lb/m

Ürün Kodu / Product Code	2222
Kalınlık / Thickness	1,4 mm
Ağırlık / Weight	1,265 kg/m 2,789 lb/m

Ürün Kodu / Product Code	2224
Kalınlık / Thickness	1,4 mm
Ağırlık / Weight	0,445 kg/m 0,981 lb/m

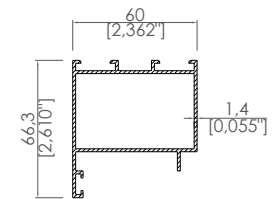
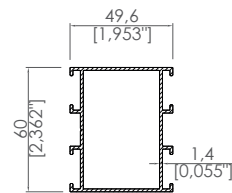
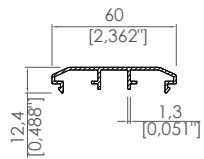

Ürün Kodu / Product Code	2225
Kalınlık / Thickness	1,3 mm
Ağırlık / Weight	0,394 kg/m 0,8686 lb/m

Ürün Kodu / Product Code	2221
Kalınlık / Thickness	1,4 mm
Ağırlık / Weight	0,963 kg/m 2,123 lb/m

Ürün Kodu / Product Code	2223
Kalınlık / Thickness	1,4 mm
Ağırlık / Weight	1,002 kg/m 2,209 lb/m

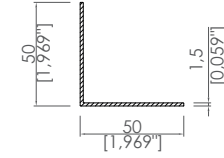
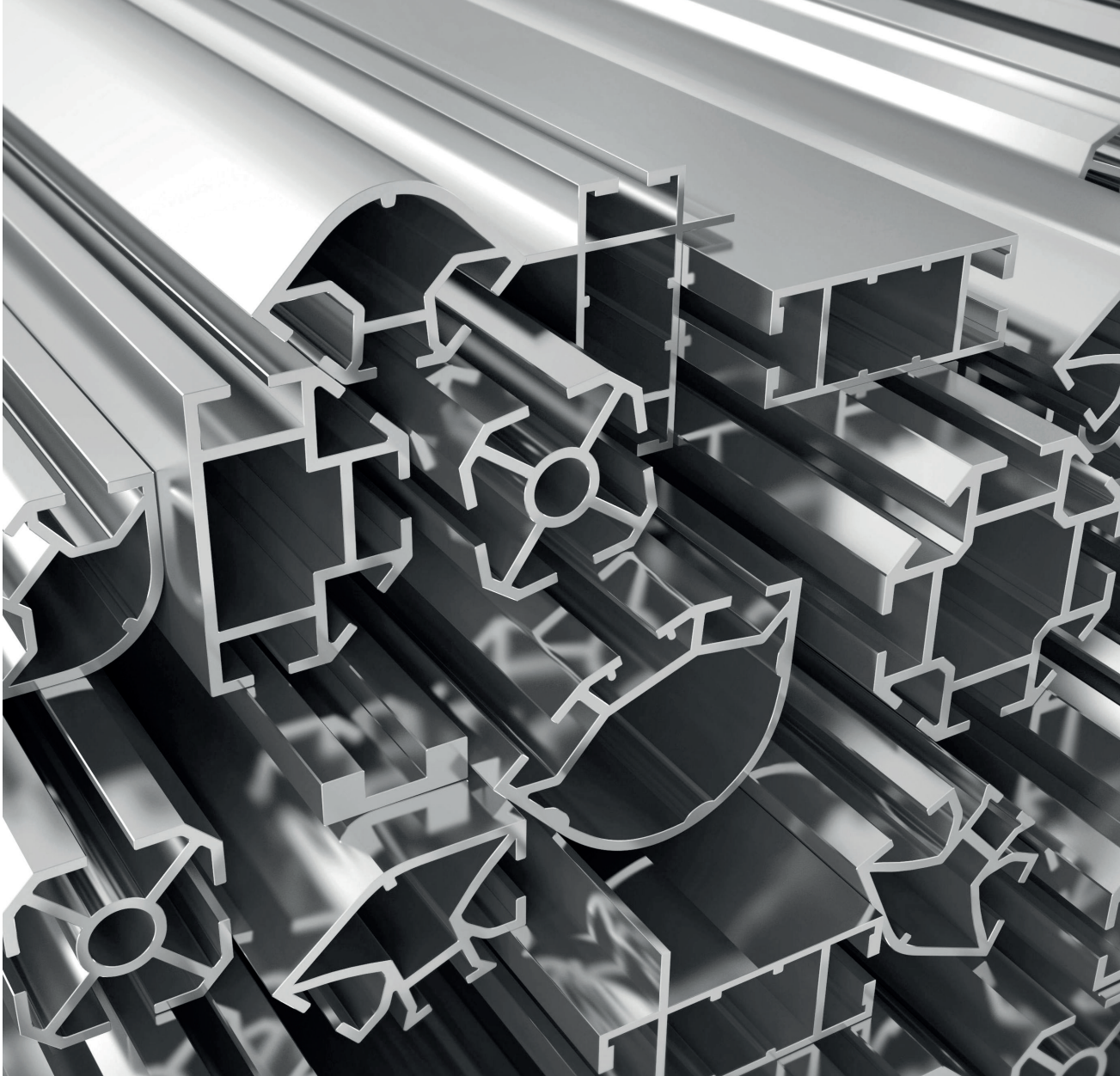

Ürün Kodu / Product Code	10043
Kalınlık / Thickness	1,5 mm
Ağırlık / Weight	0,402 kg/m 0,8863 lb/m

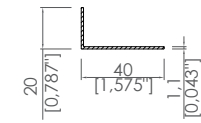

Ürün Kodu / Product Code	2394
Kalınlık / Thickness	1,1 mm
Ağırlık / Weight	0,177 kg/m 0,3902 lb/m

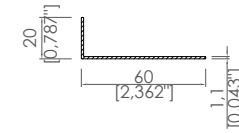
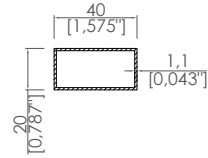
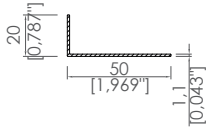

Ürün Kodu / Product Code	2395
Kalınlık / Thickness	1,1 mm
Ağırlık / Weight	0,204 kg/m 0,4497 lb/m

Ürün Kodu / Product Code	2384
Kalınlık / Thickness	1,1 mm
Ağırlık / Weight	0,347 kg/m 0,765 lb/m

Ürün Kodu / Product Code	2396
Kalınlık / Thickness	1,1 mm
Ağırlık / Weight	0,236 kg/m 0,5203 lb/m

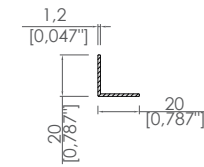
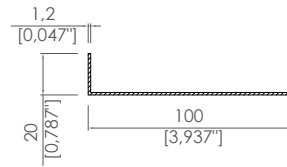
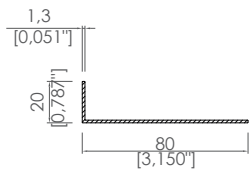

Ürün Kodu / Product Code	2397
Kalınlık / Thickness	1,3 mm
Ağırlık / Weight	0,350 kg/m 0,7716 lb/m

Ürün Kodu / Product Code	3460
Kalınlık / Thickness	1,2 mm
Ağırlık / Weight	0,388 kg/m 0,8554 lb/m

Ürün Kodu / Product Code	3458
Kalınlık / Thickness	1,2 mm
Ağırlık / Weight	0,125 kg/m 0,2756 lb/m

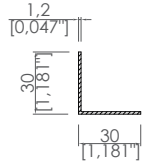

Ürün Kodu / Product Code	3459
Kalınlık / Thickness	1,2 mm
Ağırlık / Weight	0,192 kg/m 04233 lb/m

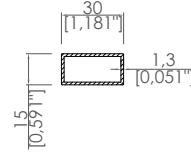

Ürün Kodu / Product Code	2002
Kalınlık / Thickness	1,3 mm
Ağırlık / Weight	0,299 kg/m 0,6592 lb/m

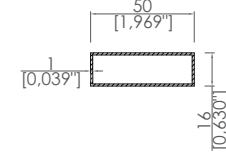

Ürün Kodu / Product Code	2609
Kalınlık / Thickness	1 mm
Ağırlık / Weight	0,350 kg/m 0,7716 lb/m

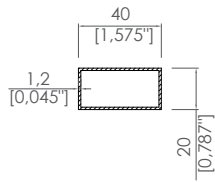

Ürün Kodu / Product Code	3594
Kalınlık / Thickness	1,2 mm
Ağırlık / Weight	0,412 kg/m 0,9083 lb/m

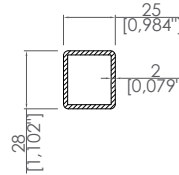

Ürün Kodu / Product Code	2974
Kalınlık / Thickness	2 mm
Ağırlık / Weight	0,518 kg/m 1,142 lb/m

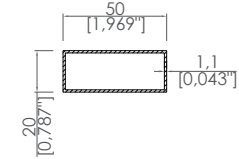

Ürün Kodu / Product Code	2386
Kalınlık / Thickness	1,1 mm
Ağırlık / Weight	0,407 kg/m 0,8973 lb/m

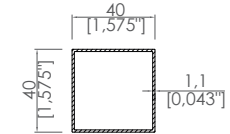
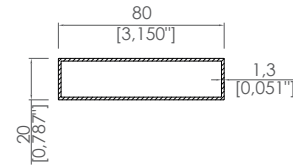
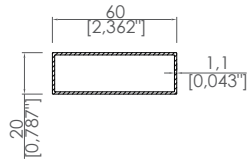

Ürün Kodu / Product Code	2387
Kalınlık / Thickness	1,1 mm
Ağırlık / Weight	0,467 kg/m 1,0296 lb/m

Ürün Kodu / Product Code	2391
Kalınlık / Thickness	1,3 mm
Ağırlık / Weight	0,689 kg/m 1,519 lb/m

Ürün Kodu / Product Code	2385
Kalınlık / Thickness	1,1 mm
Ağırlık / Weight	0,467 kg/m 1,0296 lb/m

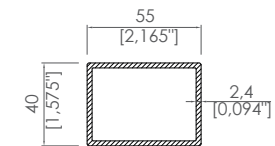
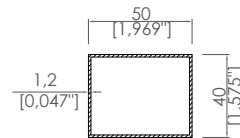
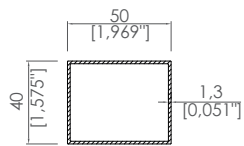

Ürün Kodu / Product Code	2388
Kalınlık / Thickness	1,3 mm
Ağırlık / Weight	0,618 kg/m 1,3625 lb/m

Ürün Kodu / Product Code	3453
Kalınlık / Thickness	1,2 mm
Ağırlık / Weight	0,569 kg/m 1,2544 lb/m

Ürün Kodu / Product Code	3634
Kalınlık / Thickness	2,4 mm
Ağırlık / Weight	1,170 kg/m 2,5794 lb/m

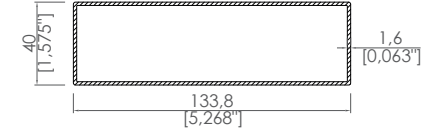
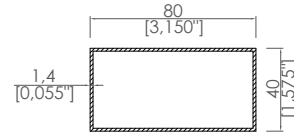
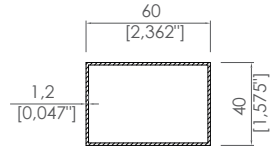

Ürün Kodu / Product Code	3454
Kalınlık / Thickness	1,2 mm
Ağırlık / Weight	0,569 kg/m 1,2544 lb/m

Ürün Kodu / Product Code	3456
Kalınlık / Thickness	1,4 mm
Ağırlık / Weight	0,889 kg/m 1,96 lb/m

Ürün Kodu / Product Code	37242
Kalınlık / Thickness	1,6 mm
Ağırlık / Weight	1,478 kg/m 3,2584 lb/m

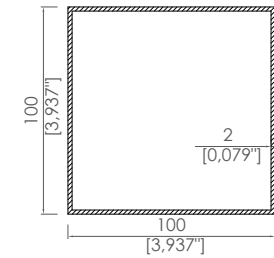
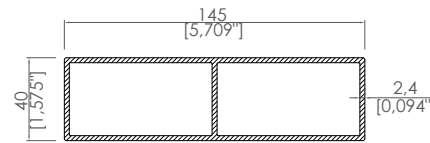
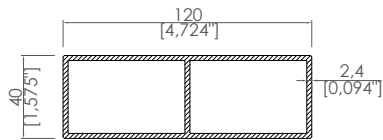

Ürün Kodu / Product Code	3637
Kalınlık / Thickness	2,4 mm
Ağırlık / Weight	2,247 kg/m 4,954 lb/m

Ürün Kodu / Product Code	3638
Kalınlık / Thickness	2,4 mm
Ağırlık / Weight	2,572 kg/m 5,67 lb/m

Ürün Kodu / Product Code	1520
Kalınlık / Thickness	2 mm
Ağırlık / Weight	2,125 kg/m 4,685 lb/m

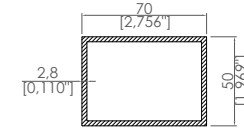
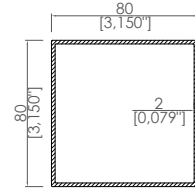
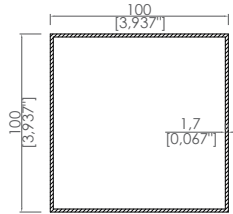

Ürün Kodu / Product Code	3366
Kalınlık / Thickness	1,7 mm
Ağırlık / Weight	1,810 kg/m 3,99 lb/m

Ürün Kodu / Product Code	2114
Kalınlık / Thickness	2 mm
Ağırlık / Weight	1,692 kg/m 3,73 lb/m

Ürün Kodu / Product Code	3305
Kalınlık / Thickness	2,8 mm
Ağırlık / Weight	1,737 kg/m 3,8294 lb/m

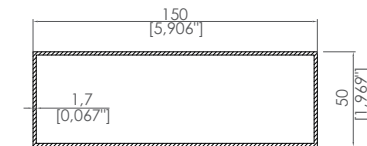
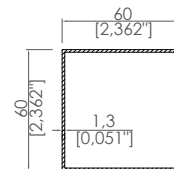
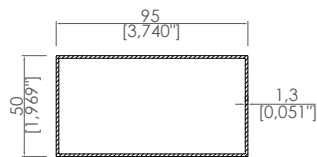

Ürün Kodu / Product Code	2389
Kalınlık / Thickness	1,3 mm
Ağırlık / Weight	1,006 kg/m 2,218 lb/m

Ürün Kodu / Product Code	2390
Kalınlık / Thickness	1,3 mm
Ağırlık / Weight	0,830 kg/m 1,83 lb/m

Ürün Kodu / Product Code	3365
Kalınlık / Thickness	1,7 mm
Ağırlık / Weight	1,810 kg/m 3,99 lb/m

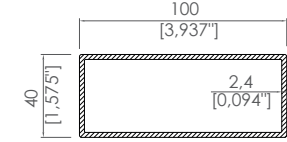
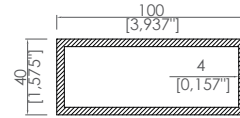
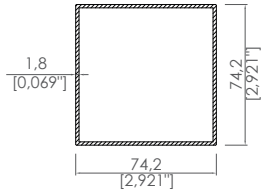

Ürün Kodu / Product Code	37186
Kalınlık / Thickness	1,8 mm
Ağırlık / Weight	1,374 kg/m 3,029 lb/m

Ürün Kodu / Product Code	43002
Kalınlık / Thickness	4 mm
Ağırlık / Weight	2,861 kg/m 6,307 lb/m

Ürün Kodu / Product Code	3636
Kalınlık / Thickness	2,4 mm
Ağırlık / Weight	1,756 kg/m 3,871 lb/m

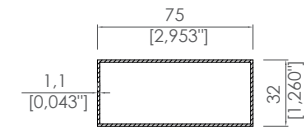
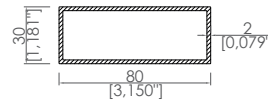
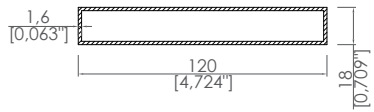

Ürün Kodu / Product Code	6351
Kalınlık / Thickness	1,6 mm
Ağırlık / Weight	1,168 kg/m 2,555 lb/m

Ürün Kodu / Product Code	2919
Kalınlık / Thickness	2 mm
Ağırlık / Weight	1,150 kg/m 2,5353 lb/m

Ürün Kodu / Product Code	3455
Kalınlık / Thickness	1,1 mm
Ağırlık / Weight	0,626 kg/m 1,38 lb/m

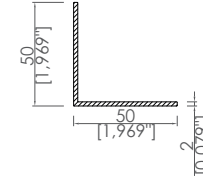
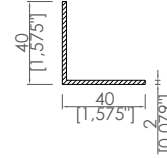
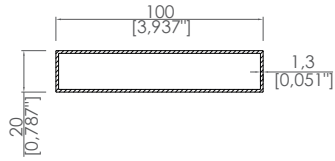

Ürün Kodu / Product Code	2392
Kalınlık / Thickness	1,3 mm
Ağırlık / Weight	0,830 kg/m 1,83 lb/m

Ürün Kodu / Product Code	10038
Kalınlık / Thickness	2 mm
Ağırlık / Weight	0,422 kg/m 0,9304 lb/m

Ürün Kodu / Product Code	10042
Kalınlık / Thickness	2 mm
Ağırlık / Weight	0,531 kg/m 1,1707 lb/m

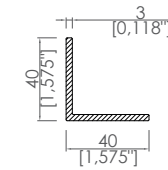
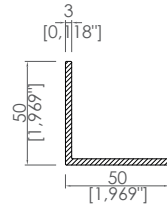
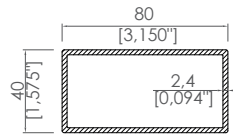

Ürün Kodu / Product Code	3635
Kalınlık / Thickness	2,4 mm
Ağırlık / Weight	1,496 kg/m 3,298 lb/m

Ürün Kodu / Product Code	3501
Kalınlık / Thickness	3 mm
Ağırlık / Weight	0,789 kg/m 1,7394 lb/m

Ürün Kodu / Product Code	3502
Kalınlık / Thickness	3 mm
Ağırlık / Weight	0,626 kg/m 1,38 lb/m

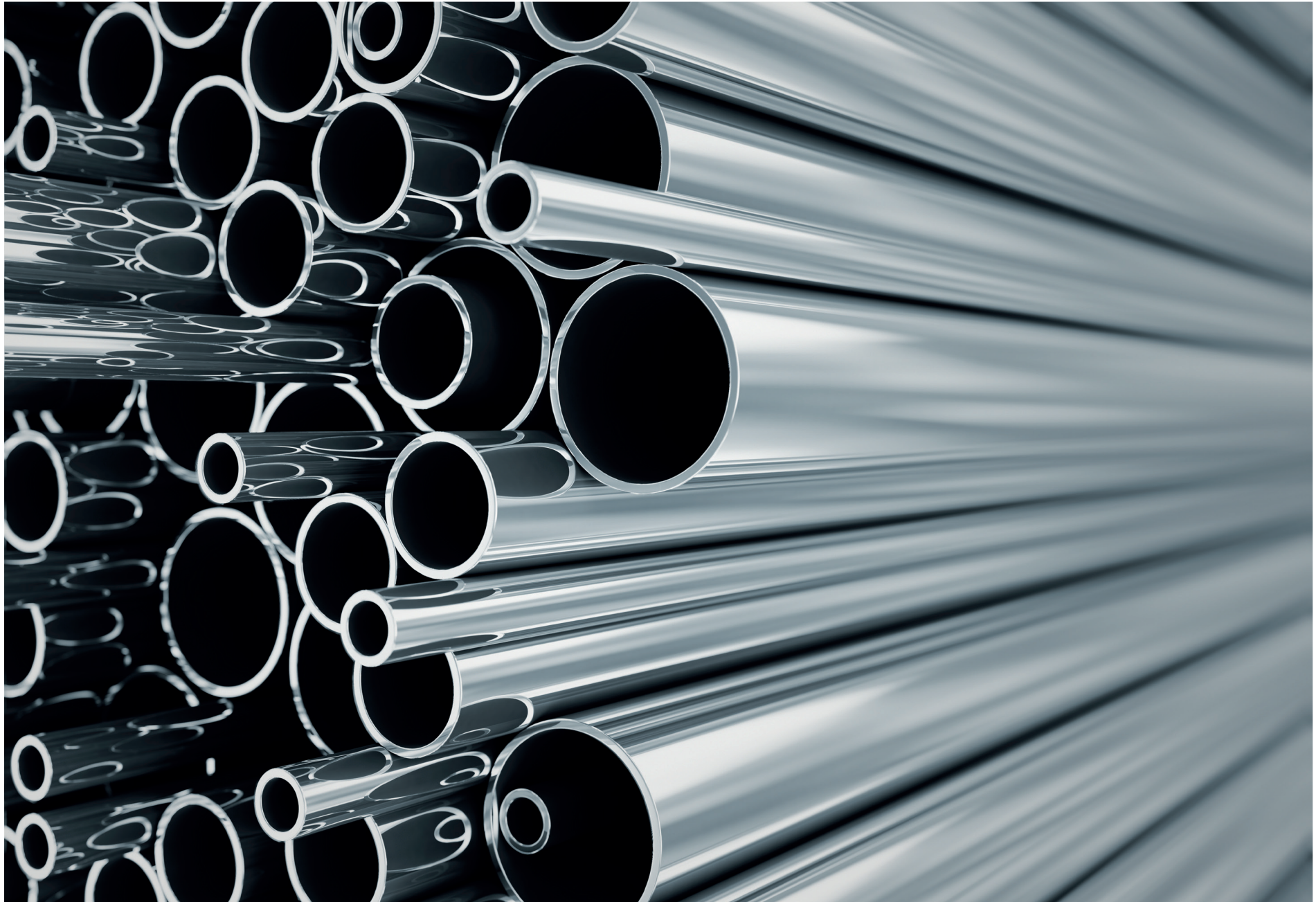

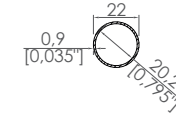
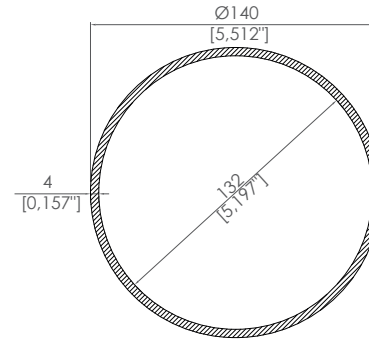
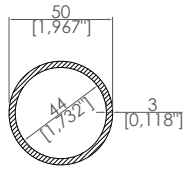

Ürün Kodu / Product Code	11431
Kalınlık / Thickness	3 mm
Ağırlık / Weight	1,197 kg/m 2,639 lb/m

Ürün Kodu / Product Code	2862
Kalınlık / Thickness	4 mm
Ağırlık / Weight	4,631 kg/m 10,21 lb/m

Ürün Kodu / Product Code	20081
Kalınlık / Thickness	0,9 mm
Ağırlık / Weight	0,162 kg/m 0,35715 lb/m

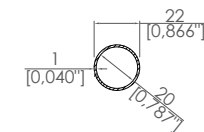
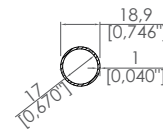
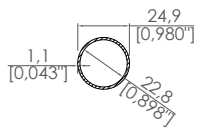

Ürün Kodu / Product Code	20302
Kalınlık / Thickness	1,1 mm
Ağırlık / Weight	0,225 kg/m 0,496 lb/m

Ürün Kodu / Product Code	20056
Kalınlık / Thickness	1 mm
Ağırlık / Weight	0,152 kg/m 0,3351 lb/m

Ürün Kodu / Product Code	20080
Kalınlık / Thickness	1 mm
Ağırlık / Weight	0,179 kg/m 0,3946 lb/m

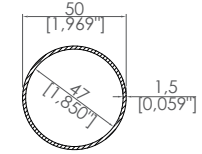
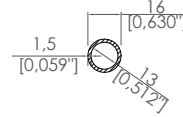
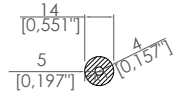

Ürün Kodu / Product Code	2624
Kalınlık / Thickness	5 mm
Ağırlık / Weight	0,385 kg/m 0,8488 lb/m

Ürün Kodu / Product Code	2181
Kalınlık / Thickness	1,5 mm
Ağırlık / Weight	0,186 kg/m 0,4101 lb/m

Ürün Kodu / Product Code	2180
Kalınlık / Thickness	1,5 mm
Ağırlık / Weight	0,620 kg/m 1,367 lb/m

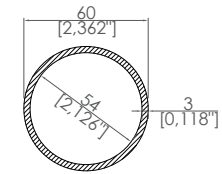
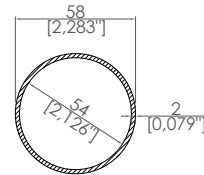
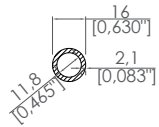

Ürün Kodu / Product Code	2931
Kalınlık / Thickness	2,1 mm
Ağırlık / Weight	0,250 kg/m 0,5512 lb/m

Ürün Kodu / Product Code	2921
Kalınlık / Thickness	2 mm
Ağırlık / Weight	0,954 kg/m 2,103 lb/m

Ürün Kodu / Product Code	43005
Kalınlık / Thickness	3 mm
Ağırlık / Weight	1,455 kg/m 3,208 lb/m

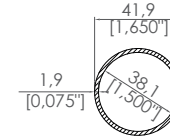
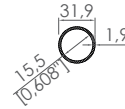
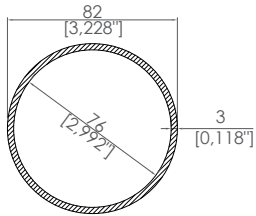

Ürün Kodu / Product Code	21345
Kalınlık / Thickness	3 mm
Ağırlık / Weight	2,019 kg/m 4,451 lb/m

Ürün Kodu / Product Code	2015
Kalınlık / Thickness	1,9 mm
Ağırlık / Weight	0,486 kg/m 1,0714 lb/m

Ürün Kodu / Product Code	2014
Kalınlık / Thickness	1,9 mm
Ağırlık / Weight	0,648 kg/m 1,4286 lb/m

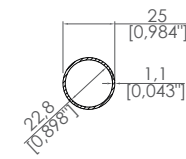
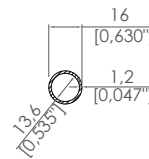
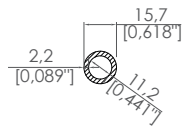

Ürün Kodu / Product Code	0038
Kalınlık / Thickness	2,2 mm
Ağırlık / Weight	0,260 kg/m 0,5732 lb/m

Ürün Kodu / Product Code	3472
Kalınlık / Thickness	1,2 mm
Ağırlık / Weight	0,152 kg/m 0,3351 lb/m

Ürün Kodu / Product Code	20302
Kalınlık / Thickness	1,1 mm
Ağırlık / Weight	0,225 kg/m 0,496 lb/m

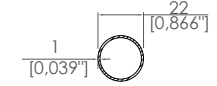
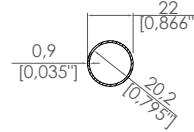
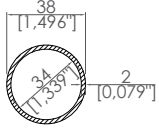

Ürün Kodu / Product Code	20298
Kalınlık / Thickness	2 mm
Ağırlık / Weight	0,612 kg/m 1,3492 lb/m

Ürün Kodu / Product Code	20081
Kalınlık / Thickness	0,9 mm
Ağırlık / Weight	0,162 kg/m 0,35715 lb/m

Ürün Kodu / Product Code	20080
Kalınlık / Thickness	1 mm
Ağırlık / Weight	0,179 kg/m 0,3946 lb/m

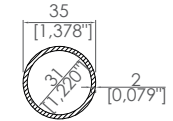
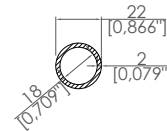
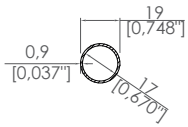

Ürün Kodu / Product Code	20056
Kalınlık / Thickness	0,9 mm
Ağırlık / Weight	0,152 kg/m 0,3351 lb/m

Ürün Kodu / Product Code	8152
Kalınlık / Thickness	2 mm
Ağırlık / Weight	0,342 kg/m 0,754 lb/m

Ürün Kodu / Product Code	3473
Kalınlık / Thickness	2 mm
Ağırlık / Weight	0,561 kg/m 1,2368 lb/m

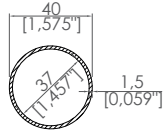

Ürün Kodu / Product Code	3474
Kalınlık / Thickness	1,5 mm
Ağırlık / Weight	0,491 kg/m 1,0825 lb/m

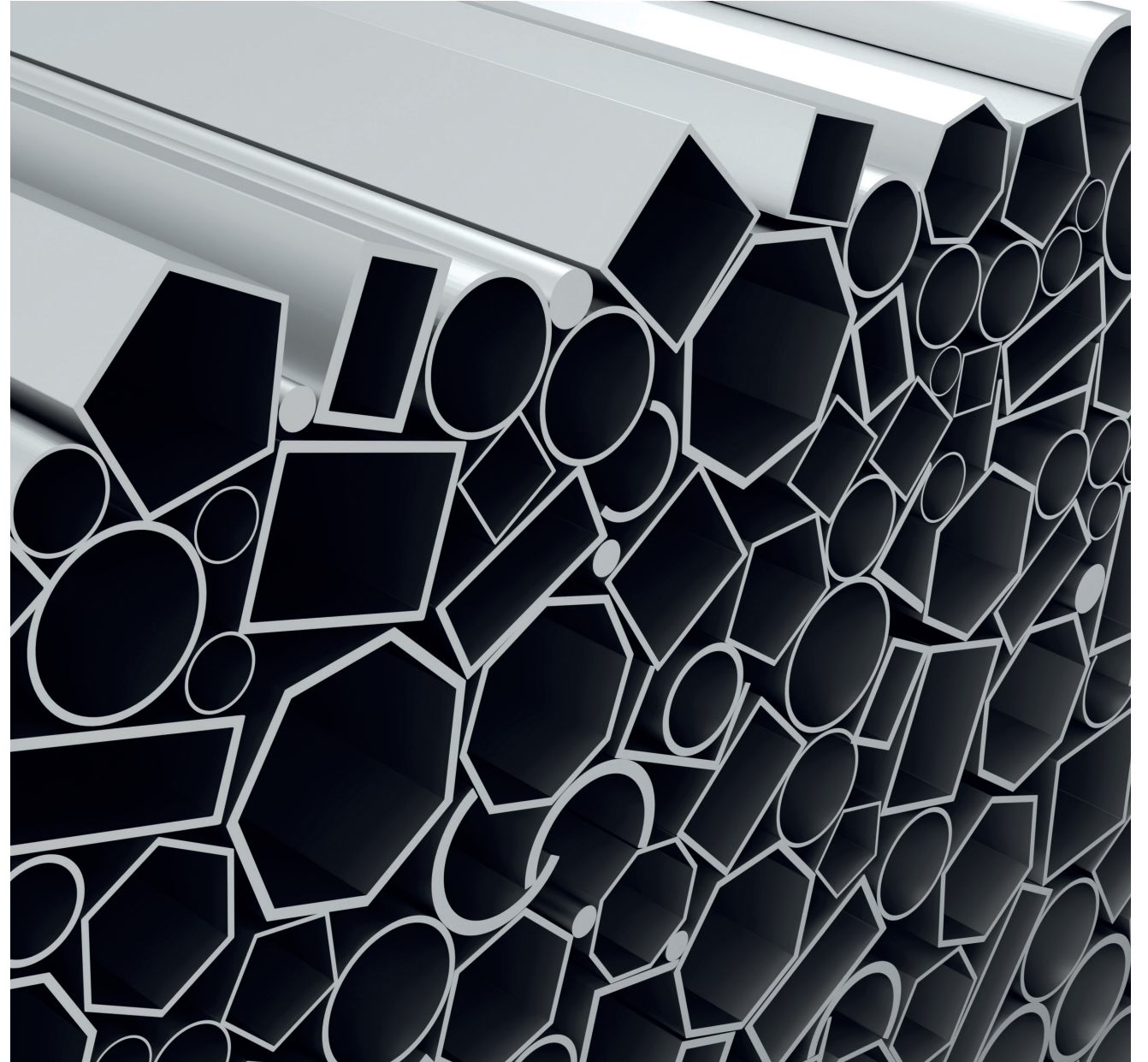

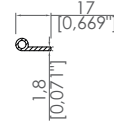

Ürün Kodu / Product Code	3262
Kalınlık / Thickness	1,8 mm
Ağırlık / Weight	0,103 kg/m 0,22708 lb/m

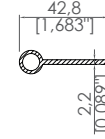

Ürün Kodu / Product Code	37212
Kalınlık / Thickness	2,2 mm
Ağırlık / Weight	0,318 kg/m 0,701 lb/m

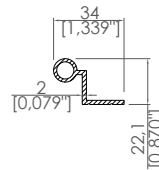

Ürün Kodu / Product Code	37214
Kalınlık / Thickness	2 mm
Ağırlık / Weight	0,326 kg/m 0,7187 lb/m

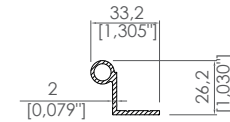

Ürün Kodu / Product Code	37213
Kalınlık / Thickness	2 mm
Ağırlık / Weight	0,346 kg/m 0,76289 lb/m

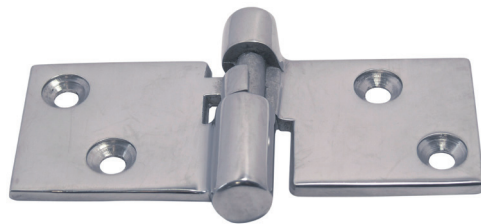

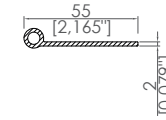
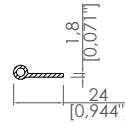
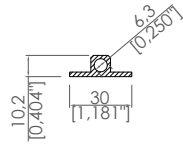

Ürün Kodu / Product Code	3166
Kalınlık / Thickness	6,3 mm
Ağırlık / Weight	0,297 kg/m 0,6548 lb/m

Ürün Kodu / Product Code	3167
Kalınlık / Thickness	1,8 mm
Ağırlık / Weight	0,149 kg/m 0,3285 lb/m

Ürün Kodu / Product Code	3168
Kalınlık / Thickness	2 mm
Ağırlık / Weight	0,369 kg/m 0,8135 lb/m

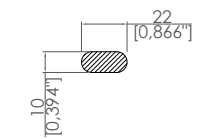
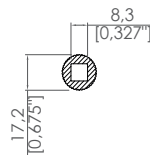
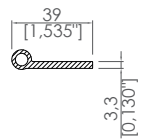

Ürün Kodu / Product Code	3169
Kalınlık / Thickness	3,3 mm
Ağırlık / Weight	0,387 kg/m 0,8532 lb/m

Ürün Kodu / Product Code	3223
Kalınlık / Thickness	8,3 mm
Ağırlık / Weight	0,420 kg/m 0,926 lb/m

Ürün Kodu / Product Code	3239
Kalınlık / Thickness	10 mm
Ağırlık / Weight	0,540 kg/m 1,1905 lb/m

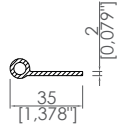

Ürün Kodu / Product Code	3256
Kalınlık / Thickness	2 mm
Ağırlık / Weight	0,260 kg/m 0,5732 lb/m

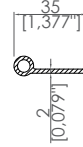

Ürün Kodu / Product Code	3257
Kalınlık / Thickness	2 mm
Ağırlık / Weight	0,257 kg/m 0,5666 lb/m

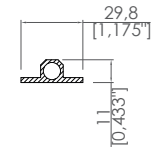

Ürün Kodu / Product Code	3258
Kalınlık / Thickness	11 mm
Ağırlık / Weight	0,285 kg/m 0,6283 lb/m

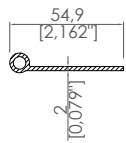

Ürün Kodu / Product Code	3259
Kalınlık / Thickness	2 mm
Ağırlık / Weight	0,366 kg/m 0,8069 lb/m

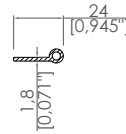

Ürün Kodu / Product Code	3260
Kalınlık / Thickness	1,8 mm
Ağırlık / Weight	0,152 kg/m 0,3351 lb/m

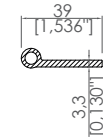

Ürün Kodu / Product Code	3261
Kalınlık / Thickness	3,3 mm
Ağırlık / Weight	0,390 kg/m 0,8598 lb/m

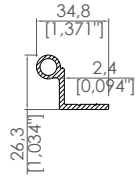

Ürün Kodu / Product Code	2053
Kalınlık / Thickness	2,4 mm
Ağırlık / Weight	0,423 kg/m 0,9326 lb/m

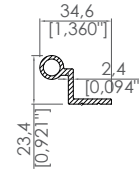

Ürün Kodu / Product Code	2054
Kalınlık / Thickness	2,4 mm
Ağırlık / Weight	0,399 kg/m 0,8796 lb/m

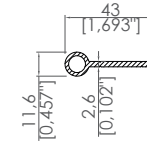

Ürün Kodu / Product Code	2055
Kalınlık / Thickness	2,6 mm
Ağırlık / Weight	0,369 kg/m 0,8135 lb/m

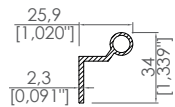

Ürün Kodu / Product Code	2151
Kalınlık / Thickness	2,3 mm
Ağırlık / Weight	0,350 kg/m 0,7716 lb/m

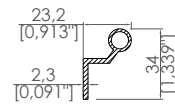

Ürün Kodu / Product Code	2152
Kalınlık / Thickness	2,3 mm
Ağırlık / Weight	0,333 kg/m 0,7341 lb/m

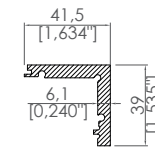

Ürün Kodu / Product Code	2373
Kalınlık / Thickness	6,1 mm
Ağırlık / Weight	1,131 kg/m 2,4934 lb/m



Ürün Kodu / Product Code	3366
Kalınlık / Thickness	6,8 mm
Ağırlık / Weight	0,171 kg/m 0,377 lb/m

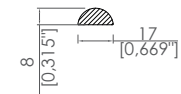

Ürün Kodu / Product Code	3243
Kalınlık / Thickness	8 mm
Ağırlık / Weight	0,285 kg/m 0,6283 lb/m

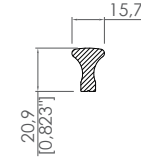
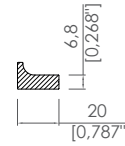
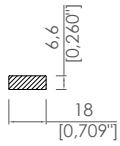

Ürün Kodu / Product Code	37091
Kalınlık / Thickness	6,6 mm
Ağırlık / Weight	0,320 kg/m 0,7099 lb/m

Ürün Kodu / Product Code	37092
Kalınlık / Thickness	6,8 mm
Ağırlık / Weight	0,428 kg/m 0,9438 lb/m

Ürün Kodu / Product Code	37123
Kalınlık / Thickness	15,7 mm
Ağırlık / Weight	0,488 kg/m 1,0759 lb/m

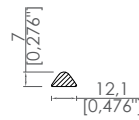
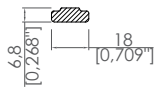

Ürün Kodu / Product Code	37124
Kalınlık / Thickness	6,8 mm
Ağırlık / Weight	0,293 kg/m 0,646 lb/m

Ürün Kodu / Product Code	2072
Kalınlık / Thickness	7 mm
Ağırlık / Weight	0,153 kg/m 0,3373 lb/m

Ürün Kodu / Product Code	2073
Kalınlık / Thickness	7 mm
Ağırlık / Weight	0,206 kg/m 0,45415 lb/m

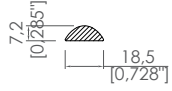

Ürün Kodu / Product Code	2074
Kalınlık / Thickness	7,2 mm
Ağırlık / Weight	0,261 kg/m 0,5754 lb/m

Ürün Kodu / Product Code	2429
Kalınlık / Thickness	7 mm
Ağırlık / Weight	0,198 kg/m 0,4365 lb/m

Ürün Kodu / Product Code	2430
Kalınlık / Thickness	7 mm
Ağırlık / Weight	0,245 kg/m 0,5401 lb/m

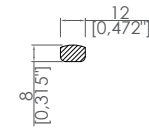
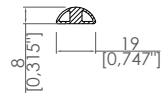
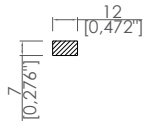

Ürün Kodu / Product Code	2431
Kalınlık / Thickness	7 mm
Ağırlık / Weight	0,228 kg/m 0,5027 lb/m

Ürün Kodu / Product Code	2627
Kalınlık / Thickness	8 mm
Ağırlık / Weight	0,212 kg/m 0,4674 lb/m

Ürün Kodu / Product Code	2146
Kalınlık / Thickness	8 mm
Ağırlık / Weight	0,241 kg/m 0,5313 lb/m



Ürün Kodu / Product Code	37054
Kalınlık / Thickness	7,9 mm
Ağırlık / Weight	0,247 kg/m 0,5445 lb/m

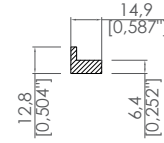

Ürün Kodu / Product Code	37055
Kalınlık / Thickness	6,4 mm
Ağırlık / Weight	0,306 kg/m 0,6746 lb/m

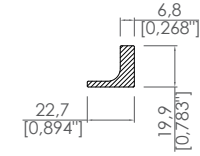

Ürün Kodu / Product Code	37056
Kalınlık / Thickness	6,8 mm
Ağırlık / Weight	0,507 kg/m 1,1177 lb/m



Ürün Kodu / Product Code	37057
Kalınlık / Thickness	7 mm
Ağırlık / Weight	0,209 kg/m 0,4608 lb/m

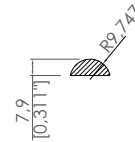

Ürün Kodu / Product Code	37058
Kalınlık / Thickness	7,9 mm
Ağırlık / Weight	0,306 kg/m 0,6746 lb/m

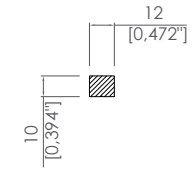

Ürün Kodu / Product Code	37090
Kalınlık / Thickness	10 mm
Ağırlık / Weight	0,325 kg/m 0,7165 lb/m

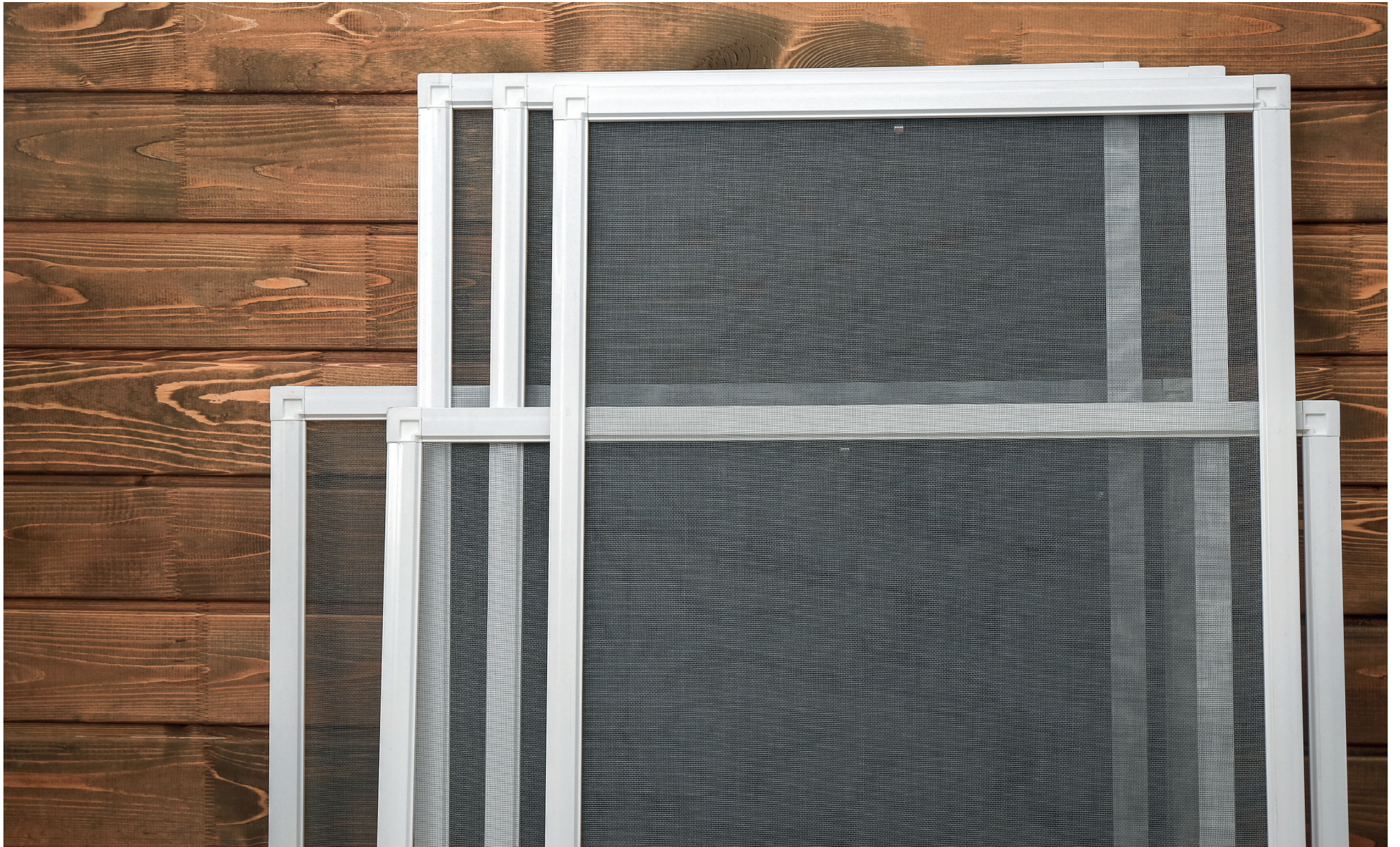

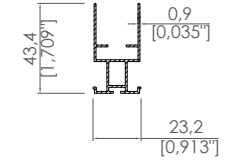

Ürün Kodu / Product Code	2629
Kalınlık / Thickness	0,9 mm
Ağırlık / Weight	0,365 kg/m 0,8047 lb/m

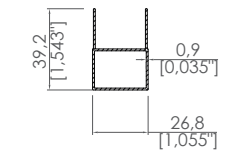

Ürün Kodu / Product Code	2628
Kalınlık / Thickness	0,9 mm
Ağırlık / Weight	0,314 kg/m 0,6923 lb/m

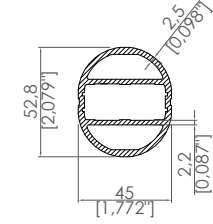
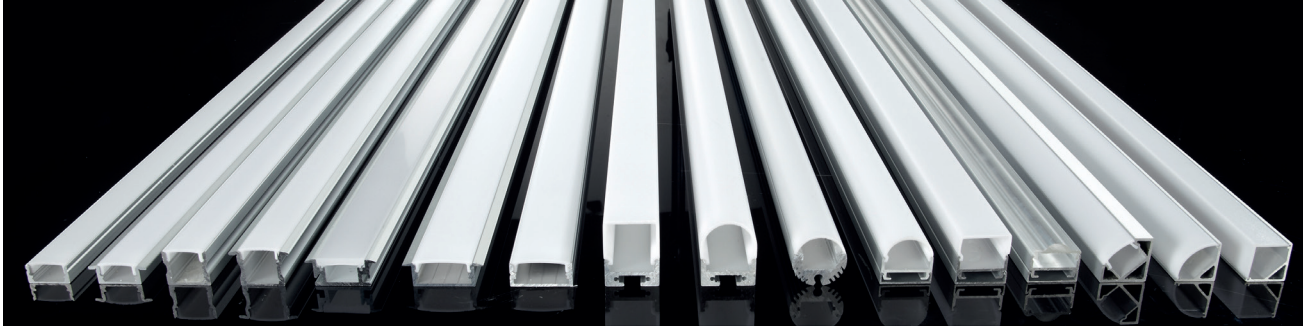

Ürün Kodu / Product Code	42103
Kalınlık / Thickness	2,2 mm
Ağırlık / Weight	1,564 kg/m 3,448 lb/m

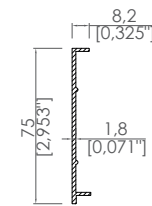
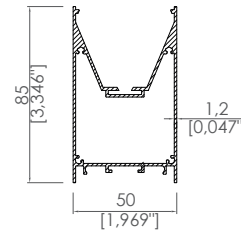
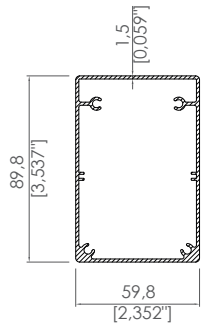

Ürün Kodu / Product Code	2607
Kalınlık / Thickness	1,5 mm
Ağırlık / Weight	1,510 kg/m 3,329 lb/m

Ürün Kodu / Product Code	2442
Kalınlık / Thickness	1,2 mm
Ağırlık / Weight	1,276 kg/m 2,813 lb/m

Ürün Kodu / Product Code	2443
Kalınlık / Thickness	1,8 mm
Ağırlık / Weight	0,431 kg/m 0,9105 lb/m

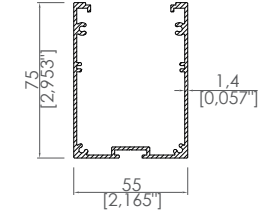
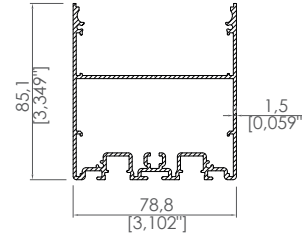
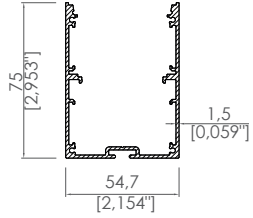

Ürün Kodu / Product Code	2215
Kalınlık / Thickness	1,5 mm
Ağırlık / Weight	1,188 kg/m 2,619 lb/m

Ürün Kodu / Product Code	2216
Kalınlık / Thickness	1,5 mm
Ağırlık / Weight	1,831 kg/m 4,037 lb/m

Ürün Kodu / Product Code	2209
Kalınlık / Thickness	1,4 mm
Ağırlık / Weight	1,148 kg/m 2,531 lb/m

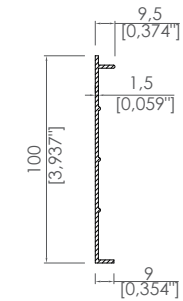
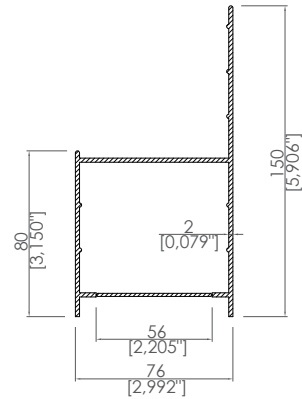
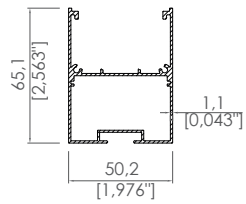

Ürün Kodu / Product Code	2608
Kalınlık / Thickness	1,1 mm
Ağırlık / Weight	0,879 kg/m 1,938 lb/m

Ürün Kodu / Product Code	2218
Kalınlık / Thickness	2 mm
Ağırlık / Weight	1,976 kg/m 4,356 lb/m

Ürün Kodu / Product Code	2273
Kalınlık / Thickness	1,5 mm
Ağırlık / Weight	0,482 kg/m 1,0626 lb/m

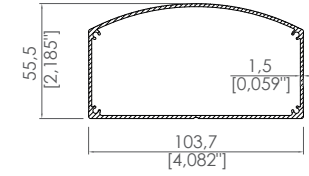
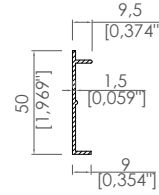
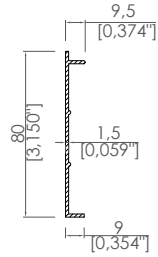

Ürün Kodu / Product Code	2274
Kalınlık / Thickness	1,5 mm
Ağırlık / Weight	0,397 kg/m 0,8752 lb/m

Ürün Kodu / Product Code	2275
Kalınlık / Thickness	1,5 mm
Ağırlık / Weight	0,270 kg/m 0,5952 lb/m

Ürün Kodu / Product Code	2206
Kalınlık / Thickness	1,5 mm
Ağırlık / Weight	1,246 kg/m 2,747 lb/m

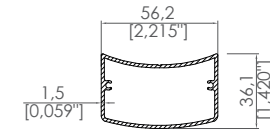
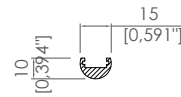
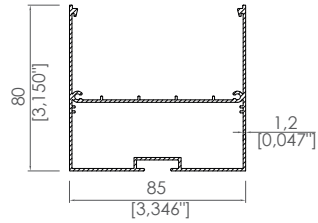

Ürün Kodu / Product Code	2763
Kalınlık / Thickness	1,2 mm
Ağırlık / Weight	1,247 kg/m 2,749 lb/m

Ürün Kodu / Product Code	42010
Kalınlık / Thickness	10 mm
Ağırlık / Weight	0,200 kg/m 0,4409 lb/m

Ürün Kodu / Product Code	2406
Kalınlık / Thickness	1,5 mm
Ağırlık / Weight	0,748 kg/m 1,649 lb/m

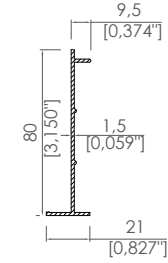
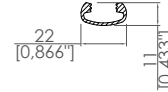
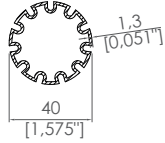

Ürün Kodu / Product Code	42001
Kalınlık / Thickness	1,3 mm
Ağırlık / Weight	0,677 kg/m 1,4925 lb/m

Ürün Kodu / Product Code	37098
Kalınlık / Thickness	11 mm
Ağırlık / Weight	0,190 kg/m 0,4189 lb/m

Ürün Kodu / Product Code	2276
Kalınlık / Thickness	1,5 mm
Ağırlık / Weight	0,446 kg/m 0,9833 lb/m

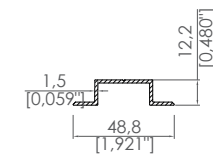
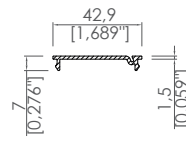
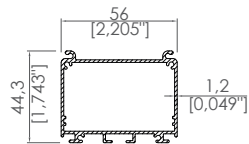

Ürün Kodu / Product Code	2277
Kalınlık / Thickness	1,2 mm
Ağırlık / Weight	0,845 kg/m 1,863 lb/m

Ürün Kodu / Product Code	2217
Kalınlık / Thickness	1,5 mm
Ağırlık / Weight	0,230 kg/m 0,5071 lb/m

Ürün Kodu / Product Code	2353
Kalınlık / Thickness	1,5 mm
Ağırlık / Weight	0,282 kg/m 0,6217 lb/m

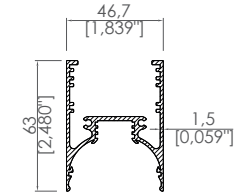
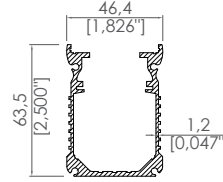
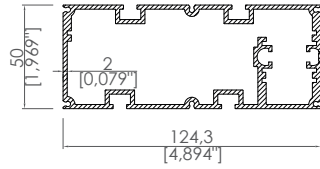

Ürün Kodu / Product Code	2354
Kalınlık / Thickness	2 mm
Ağırlık / Weight	2,843 kg/m 6,268 lb/m

Ürün Kodu / Product Code	42002
Kalınlık / Thickness	1,2 mm
Ağırlık / Weight	1,297 kg/m 2,8594 lb/m

Ürün Kodu / Product Code	42004
Kalınlık / Thickness	1,5 mm
Ağırlık / Weight	0,413 kg/m 0,9105 lb/m

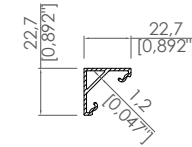
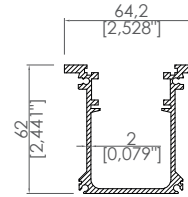
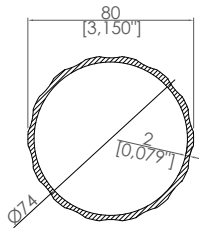

Ürün Kodu / Product Code	42003
Kalınlık / Thickness	2 mm
Ağırlık / Weight	0,623 kg/m 1,3735 lb/m

Ürün Kodu / Product Code	42005
Kalınlık / Thickness	2 mm
Ağırlık / Weight	0,530 kg/m 1,1684 lb/m

Ürün Kodu / Product Code	3085
Kalınlık / Thickness	1,2 mm
Ağırlık / Weight	0,250 kg/m 0,5512 lb/m

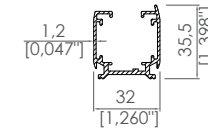
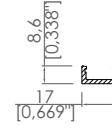
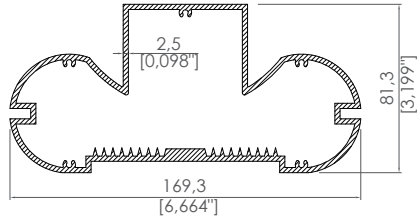

Ürün Kodu / Product Code	3267
Kalınlık / Thickness	2,5 mm
Ağırlık / Weight	4,190 kg/m 9,237 lb/m

Ürün Kodu / Product Code	42009
Kalınlık / Thickness	8,6 mm
Ağırlık / Weight	0,160 kg/m 0,35274 lb/m

Ürün Kodu / Product Code	2303
Kalınlık / Thickness	1,2 mm
Ağırlık / Weight	0,527 kg/m 1,1618 lb/m

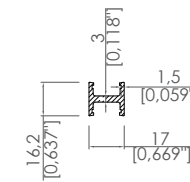
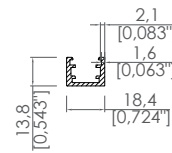
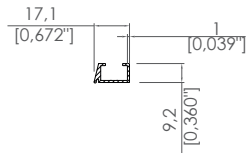

Ürün Kodu / Product Code	3356
Kalınlık / Thickness	1 mm
Ağırlık / Weight	0,119 kg/m 0,26235 lb/m

Ürün Kodu / Product Code	42007
Kalınlık / Thickness	1,6 mm
Ağırlık / Weight	0,251 kg/m 0,5534 lb/m

Ürün Kodu / Product Code	42011
Kalınlık / Thickness	1,5 mm
Ağırlık / Weight	0,276 kg/m 0,6085 lb/m

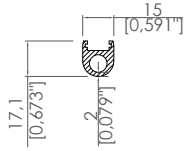

Ürün Kodu / Product Code	42012
Kalınlık / Thickness	2 mm
Ağırlık / Weight	0,333 kg/m 0,7341 lb/m

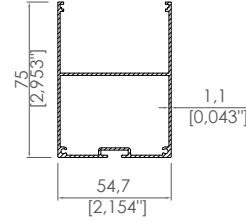

Ürün Kodu / Product Code	2600
Kalınlık / Thickness	1,1 mm
Ağırlık / Weight	0,859 kg/m 1,8938 lb/m

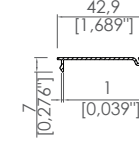

Ürün Kodu / Product Code	2601
Kalınlık / Thickness	1 mm
Ağırlık / Weight	0,160 kg/m 0,35274 lb/m

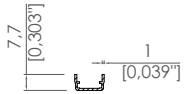

Ürün Kodu / Product Code	2602
Kalınlık / Thickness	1 mm
Ağırlık / Weight	0,076 kg/m 0,16755 lb/m

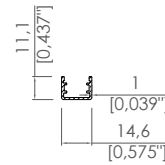

Ürün Kodu / Product Code	2603
Kalınlık / Thickness	1 mm
Ağırlık / Weight	0,120 kg/m 0,26455 lb/m

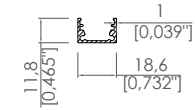

Ürün Kodu / Product Code	2604
Kalınlık / Thickness	1 mm
Ağırlık / Weight	0,160 kg/m 0,35274 lb/m

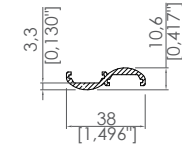
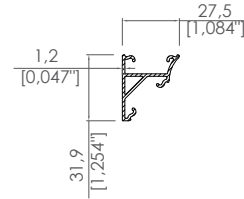
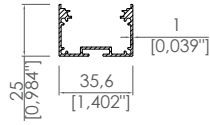

Ürün Kodu / Product Code	2605
Kalınlık / Thickness	1 mm
Ağırlık / Weight	0,380 kg/m 0,8378 lb/m

Ürün Kodu / Product Code	3086
Kalınlık / Thickness	1,2 mm
Ağırlık / Weight	0,352 kg/m 0,776 lb/m

Ürün Kodu / Product Code	2296
Kalınlık / Thickness	3,3 mm
Ağırlık / Weight	0,321 kg/m 0,7077 lb/m

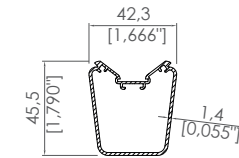
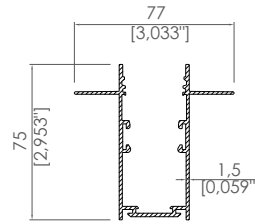
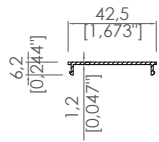

Ürün Kodu / Product Code	2599
Kalınlık / Thickness	1,2 mm
Ağırlık / Weight	0,171 kg/m 0,377 lb/m

Ürün Kodu / Product Code	2587
Kalınlık / Thickness	1,5 mm
Ağırlık / Weight	1,087 kg/m 2,3964 lb/m

Ürün Kodu / Product Code	2588
Kalınlık / Thickness	1,4 mm
Ağırlık / Weight	0,640 kg/m 1,411 lb/m

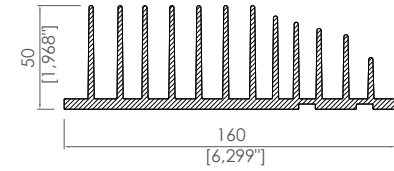
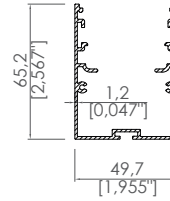
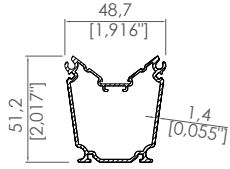

Ürün Kodu / Product Code	2593
Kalınlık / Thickness	1,4 mm
Ağırlık / Weight	0,827 kg/m 1,8232 lb/m

Ürün Kodu / Product Code	2613
Kalınlık / Thickness	1,2 mm
Ağırlık / Weight	0,945 kg/m 2,0834 lb/m

Ürün Kodu / Product Code	3164
Kalınlık / Thickness	50 mm
Ağırlık / Weight	5,265 kg/m 11,607 lb/m

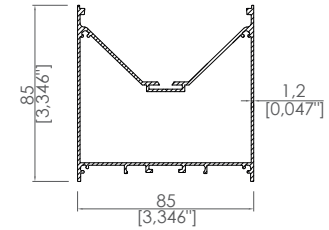
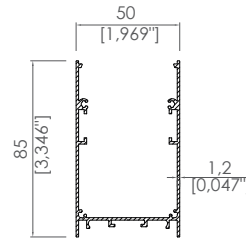
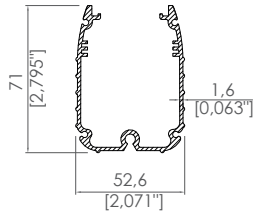

Ürün Kodu / Product Code	2445
Kalınlık / Thickness	1,6 mm
Ağırlık / Weight	1,215 kg/m 2,6786 lb/m

Ürün Kodu / Product Code	2598
Kalınlık / Thickness	1,2 mm
Ağırlık / Weight	0,930 kg/m 2,0503 lb/m

Ürün Kodu / Product Code	2441
Kalınlık / Thickness	1,2 mm
Ağırlık / Weight	1,420 kg/m 3,1306 lb/m

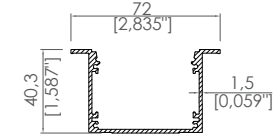
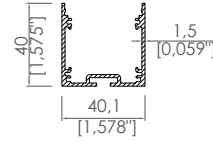
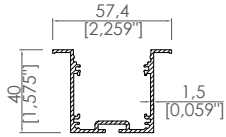

Ürün Kodu / Product Code	2211
Kalınlık / Thickness	1,5 mm
Ağırlık / Weight	0,720 kg/m 1,5873 lb/m

Ürün Kodu / Product Code	2212
Kalınlık / Thickness	1,5 mm
Ağırlık / Weight	0,655 kg/m 1,444 lb/m

Ürün Kodu / Product Code	2213
Kalınlık / Thickness	1,5 mm
Ağırlık / Weight	0,840 kg/m 1,852 lb/m

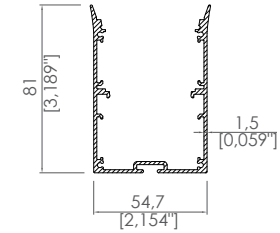
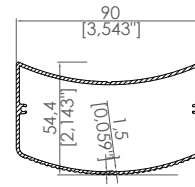
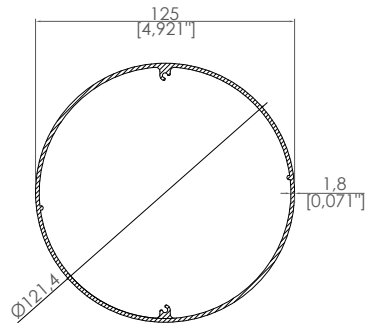

Ürün Kodu / Product Code	2200
Kalınlık / Thickness	1,8 mm
Ağırlık / Weight	2,030 kg/m 4,475 lb/m

Ürün Kodu / Product Code	2205
Kalınlık / Thickness	1,5 mm
Ağırlık / Weight	1,083 kg/m 0,183 lb/m

Ürün Kodu / Product Code	2214
Kalınlık / Thickness	1,5 mm
Ağırlık / Weight	1,250 kg/m 2,756 lb/m

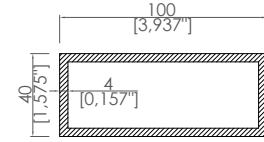
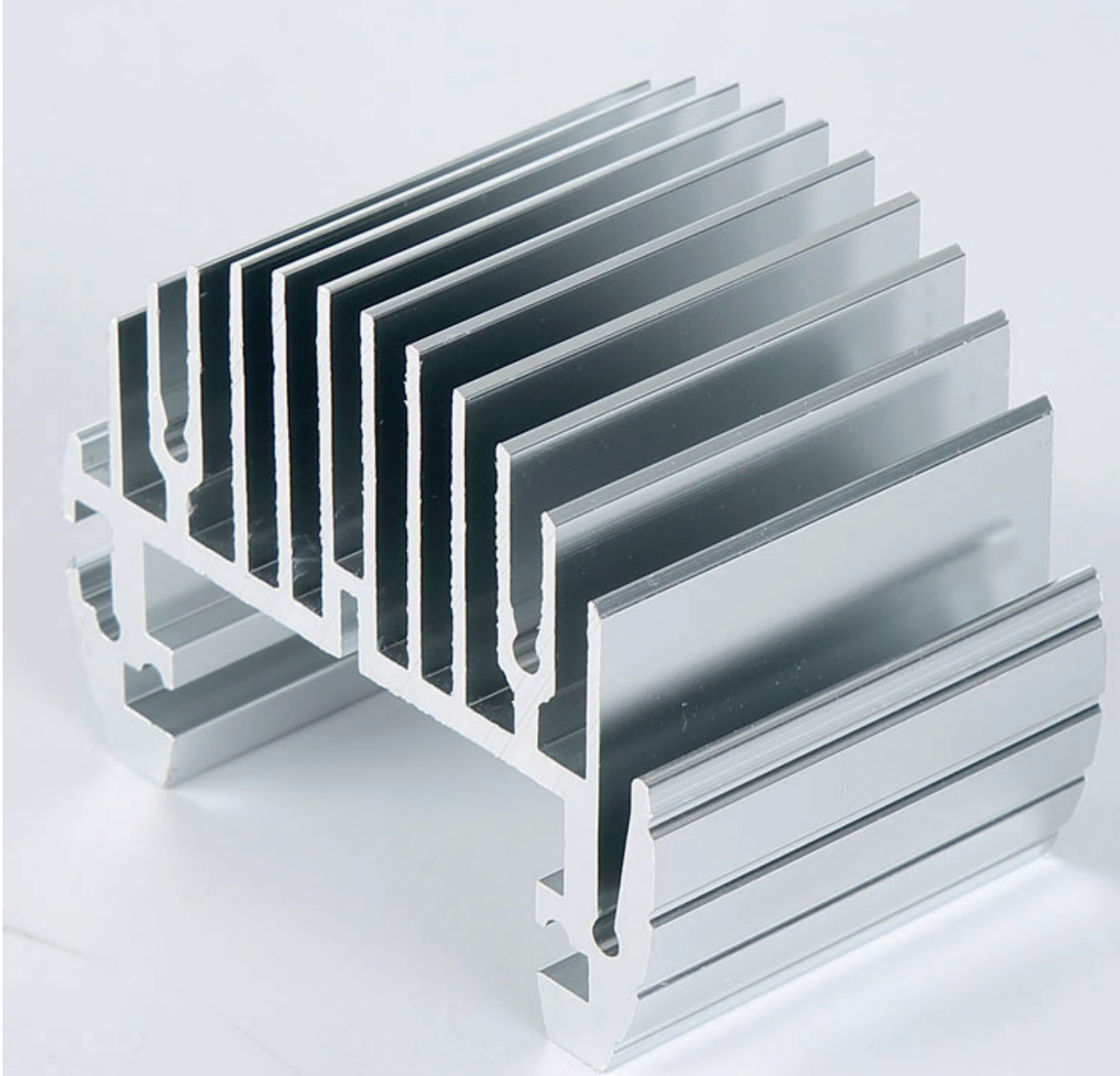

Ürün Kodu / Product Code	43002
Kalınlık / Thickness	4 mm
Ağırlık / Weight	2,861 kg/m 6,307 lb/m

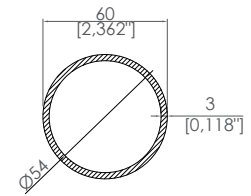

Ürün Kodu / Product Code	43005
Kalınlık / Thickness	3 mm
Ağırlık / Weight	1,455 kg/m 3,208 lb/m

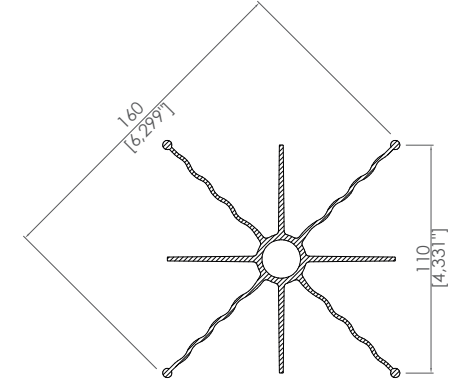
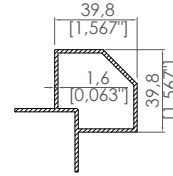
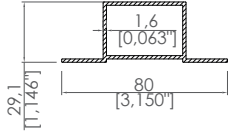

Ürün Kodu / Product Code	37049
Kalınlık / Thickness	1,6 mm
Ağırlık / Weight	0,745 kg/m 1,6424 lb/m

Ürün Kodu / Product Code	37050
Kalınlık / Thickness	1,6 mm
Ağırlık / Weight	0,788 kg/m 1,7372 lb/m

Ürün Kodu / Product Code	43001
Kalınlık / Thickness	1,5 mm
Ağırlık / Weight	2,943 kg/m 6,488 lb/m

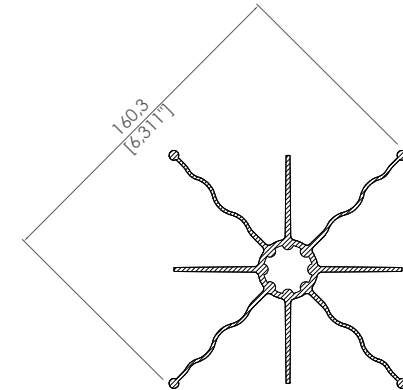
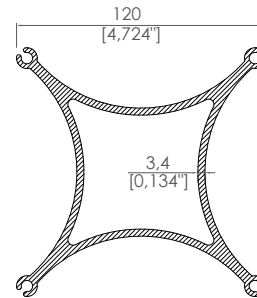
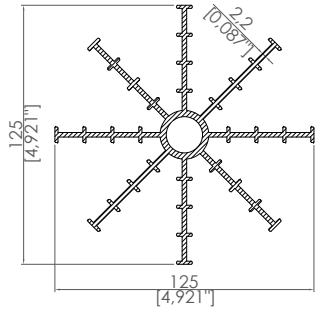

Ürün Kodu / Product Code	43003
Kalınlık / Thickness	2,2 mm
Ağırlık / Weight	3,615 kg/m 7,97 lb/m

Ürün Kodu / Product Code	43004
Kalınlık / Thickness	3,4 mm
Ağırlık / Weight	4,658 kg/m 10,27 lb/m

Ürün Kodu / Product Code	43006
Kalınlık / Thickness	1,5 mm
Ağırlık / Weight	3,124 kg/m 6,887 lb/m

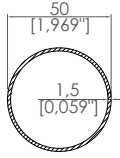

Ürün Kodu / Product Code	2180
Kalınlık / Thickness	1,5 mm
Ağırlık / Weight	0,620 kg/m 1,367 lb/m

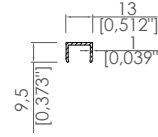

Ürün Kodu / Product Code	3466
Kalınlık / Thickness	1 mm
Ağırlık / Weight	0,087 kg/m 0,1918 lb/m

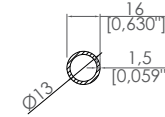

Ürün Kodu / Product Code	2181
Kalınlık / Thickness	1,5 mm
Ağırlık / Weight	0,186 kg/m 0,4101 lb/m

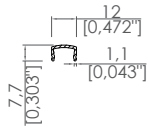

Ürün Kodu / Product Code	3464
Kalınlık / Thickness	1,1 mm
Ağırlık / Weight	0,073 kg/m 0,16094 lb/m

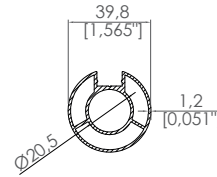

Ürün Kodu / Product Code	3463
Kalınlık / Thickness	1,2 mm
Ağırlık / Weight	0,735 kg/m 1,6204 lb/m

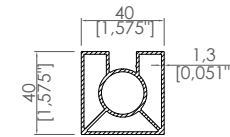

Ürün Kodu / Product Code	3465
Kalınlık / Thickness	1,3 mm
Ağırlık / Weight	0,927 kg/m 2,0437 lb/m

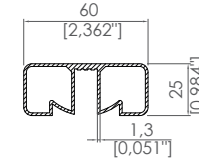
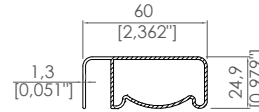
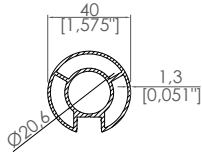

Ürün Kodu / Product Code	2182
Kalınlık / Thickness	1,3 mm
Ağırlık / Weight	0,808 kg/m 1,7813 lb/m

Ürün Kodu / Product Code	3469
Kalınlık / Thickness	1,3 mm
Ağırlık / Weight	0,629 kg/m 1,3867 lb/m

Ürün Kodu / Product Code	3471
Kalınlık / Thickness	1,3 mm
Ağırlık / Weight	0,786 kg/m 1,733 lb/m

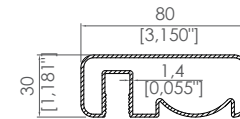
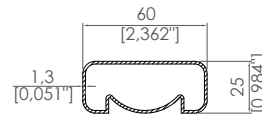

Ürün Kodu / Product Code	3470
Kalınlık / Thickness	1,3 mm
Ağırlık / Weight	0,610 kg/m 1,3228 lb/m

Ürün Kodu / Product Code	3468
Kalınlık / Thickness	1,4 mm
Ağırlık / Weight	1,022 kg/m 2,209 lb/m



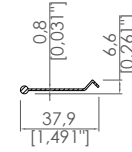

Ürün Kodu / Product Code	3385
Kalınlık / Thickness	0,8 mm
Ağırlık / Weight	0,111 kg/m 0,2447 lb/m

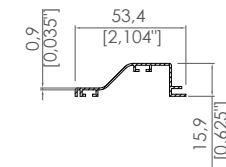

Ürün Kodu / Product Code	3386
Kalınlık / Thickness	0,9 mm
Ağırlık / Weight	0,250 kg/m 0,5512 lb/m



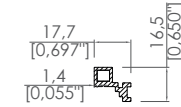
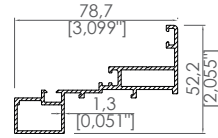
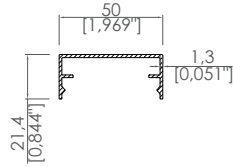

Ürün Kodu / Product Code	2349
Kalınlık / Thickness	1,3 mm
Ağırlık / Weight	0,400 kg/m 0,8818 lb/m

Ürün Kodu / Product Code	2361
Kalınlık / Thickness	1,3 mm
Ağırlık / Weight	0,938 kg/m 2,068 lb/m

Ürün Kodu / Product Code	2351
Kalınlık / Thickness	1,4 mm
Ağırlık / Weight	0,253 kg/m 0,5578 lb/m

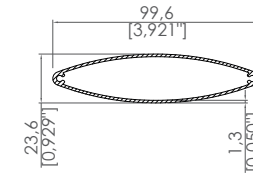
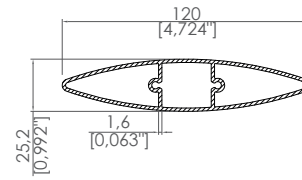
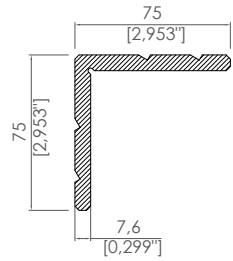

Ürün Kodu / Product Code	2364
Kalınlık / Thickness	7,6 mm
Ağırlık / Weight	2,819 kg/m 6,215 lb/m

Ürün Kodu / Product Code	37106
Kalınlık / Thickness	1,6 mm
Ağırlık / Weight	1,325 kg/m 2,921 lb/m

Ürün Kodu / Product Code	3467
Kalınlık / Thickness	1,3 mm
Ağırlık / Weight	0,748 kg/m 1,649 lb/m

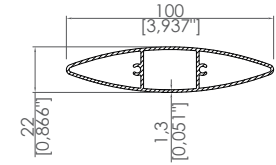
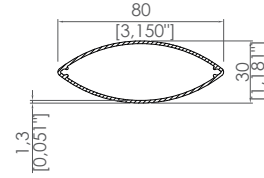
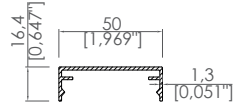

Ürün Kodu / Product Code	2362
Kalınlık / Thickness	1,3 mm
Ağırlık / Weight	0,364 kg/m 0,8025 lb/m

Ürün Kodu / Product Code	2596
Kalınlık / Thickness	1,3 mm
Ağırlık / Weight	0,626 kg/m 1,38 lb/m

Ürün Kodu / Product Code	2398
Kalınlık / Thickness	1,3 mm
Ağırlık / Weight	0,908 kg/m 2,0018 lb/m

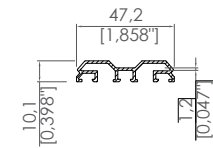
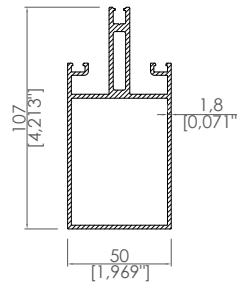
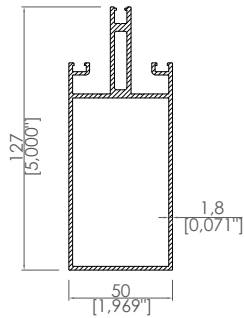

Ürün Kodu / Product Code	2346
Kalınlık / Thickness	1,8 mm
Ağırlık / Weight	2,115 kg/m 4,663 lb/m

Ürün Kodu / Product Code	2347
Kalınlık / Thickness	1,8 mm
Ağırlık / Weight	1,920 kg/m 4,233 lb/m

Ürün Kodu / Product Code	2350
Kalınlık / Thickness	1,2 mm
Ağırlık / Weight	0,353 kg/m 0,7782 lb/m

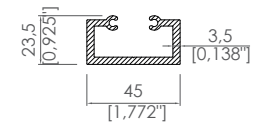
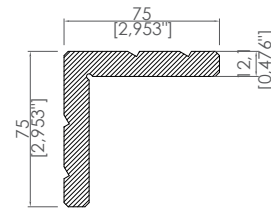
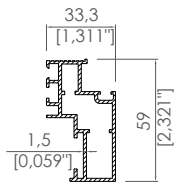

Ürün Kodu / Product Code	2352
Kalınlık / Thickness	1,5 mm
Ağırlık / Weight	0,884 kg/m 1,494 lb/m

Ürün Kodu / Product Code	2363
Kalınlık / Thickness	12,1 mm
Ağırlık / Weight	4,407 kg/m 9,716 lb/m

Ürün Kodu / Product Code	2348
Kalınlık / Thickness	3,5 mm
Ağırlık / Weight	0,981 kg/m 2,1627 lb/m



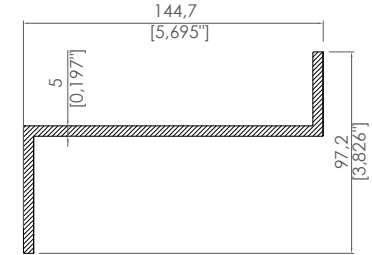
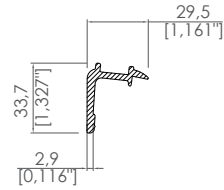
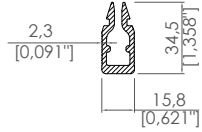

Ürün Kodu / Product Code	3339
Kalınlık / Thickness	2,3 mm
Ağırlık / Weight	0,621 kg/m 1,369 lb/m

Ürün Kodu / Product Code	3340
Kalınlık / Thickness	2,9 mm
Ağırlık / Weight	0,539 kg/m 1,1883 lb/m

Ürün Kodu / Product Code	3505
Kalınlık / Thickness	5 mm
Ağırlık / Weight	3,190 kg/m 7,033 lb/m

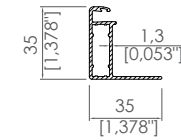
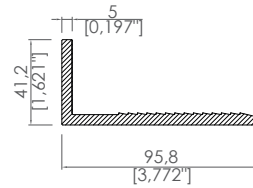
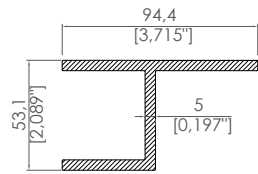

Ürün Kodu / Product Code	3503
Kalınlık / Thickness	5 mm
Ağırlık / Weight	2,461 kg/m 5,426 lb/m

Ürün Kodu / Product Code	3506
Kalınlık / Thickness	5 mm
Ağırlık / Weight	1,856 kg/m 4,092 lb/m

Ürün Kodu / Product Code	3272
Kalınlık / Thickness	1,3 mm
Ağırlık / Weight	0,423 kg/m 0,9326 lb/m

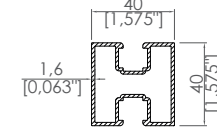
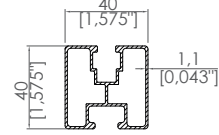
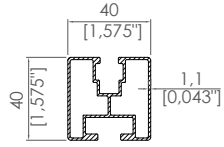

Ürün Kodu / Product Code	3338
Kalınlık / Thickness	1,1 mm
Ağırlık / Weight	0,797 kg/m 1,757 lb/m

Ürün Kodu / Product Code	3287
Kalınlık / Thickness	1,1 mm
Ağırlık / Weight	0,764 kg/m 1,6843 lb/m

Ürün Kodu / Product Code	3534
Kalınlık / Thickness	1,6 mm
Ağırlık / Weight	0,905 kg/m 1,995 lb/m

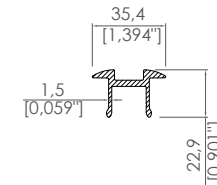
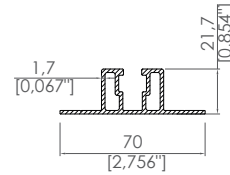
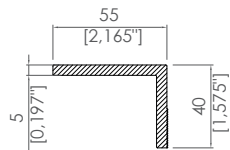

Ürün Kodu / Product Code	3504
Kalınlık / Thickness	5 mm
Ağırlık / Weight	1,230 kg/m 2,7117 lb/m

Ürün Kodu / Product Code	3507
Kalınlık / Thickness	1,7 mm
Ağırlık / Weight	0,794 kg/m 1,7505 lb/m

Ürün Kodu / Product Code	3341
Kalınlık / Thickness	1,5 mm
Ağırlık / Weight	0,477 kg/m 1,0516 lb/m

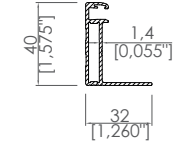

Ürün Kodu / Product Code	3476
Kalınlık / Thickness	1,4 mm
Ağırlık / Weight	0,461 kg/m 1,0163 lb/m

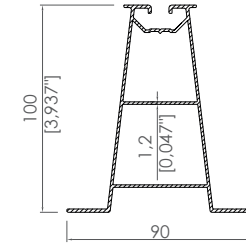

Ürün Kodu / Product Code	3290
Kalınlık / Thickness	1,2 mm
Ağırlık / Weight	1,327 kg/m 2,9255 lb/m



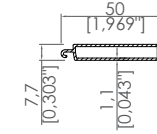
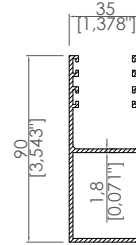
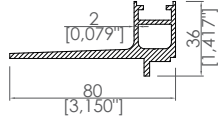

Ürün Kodu / Product Code	35020
Kalınlık / Thickness	2 mm
Ağırlık / Weight	1,285 kg/m 2,833 lb/m

Ürün Kodu / Product Code	35019
Kalınlık / Thickness	1,8 mm
Ağırlık / Weight	1,317 kg/m 2,9035 lb/m

Ürün Kodu / Product Code	35023
Kalınlık / Thickness	1,1 mm
Ağırlık / Weight	0,332 kg/m 0,732 lb/m

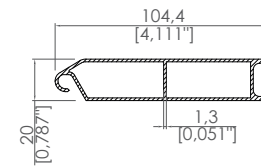
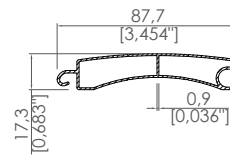
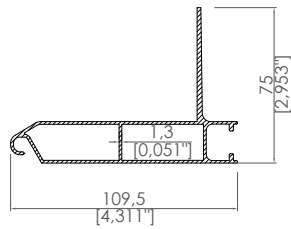

Ürün Kodu / Product Code	35026
Kalınlık / Thickness	1,3 mm
Ağırlık / Weight	1,321 kg/m 2,9123 lb/m

Ürün Kodu / Product Code	35022
Kalınlık / Thickness	0,9 mm
Ağırlık / Weight	0,584 kg/m 1,2875 lb/m

Ürün Kodu / Product Code	35021
Kalınlık / Thickness	1,3 mm
Ağırlık / Weight	0,973 kg/m 2,145 lb/m

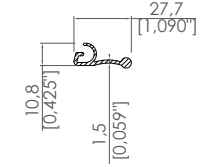
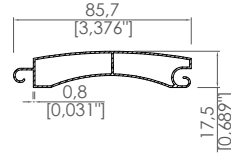
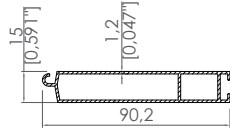

Ürün Kodu / Product Code	35018
Kalınlık / Thickness	1,2 mm
Ağırlık / Weight	0,720 kg/m 1,5873 lb/m

Ürün Kodu / Product Code	35017
Kalınlık / Thickness	0,8 mm
Ağırlık / Weight	0,480 kg/m 1,0582 lb/m

Ürün Kodu / Product Code	3103
Kalınlık / Thickness	1,5 mm
Ağırlık / Weight	0,214 kg/m 0,4718 lb/m

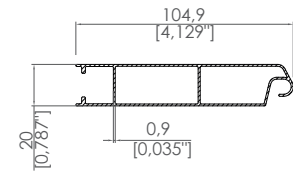
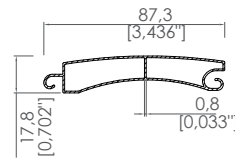
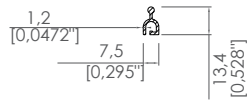

Ürün Kodu / Product Code	3102
Kalınlık / Thickness	1,2 mm
Ağırlık / Weight	0,098 kg/m 0,21605 lb/m

Ürün Kodu / Product Code	3477
Kalınlık / Thickness	0,8 mm
Ağırlık / Weight	0,526 kg/m 1,1596 lb/m

Ürün Kodu / Product Code	3199
Kalınlık / Thickness	0,9 mm
Ağırlık / Weight	0,705 kg/m 1,5543 lb/m

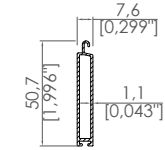
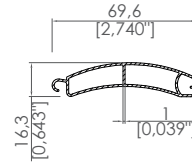
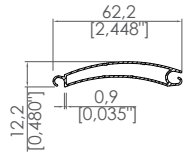

Ürün Kodu / Product Code	3105
Kalınlık / Thickness	0,9 mm
Ağırlık / Weight	0,317 kg/m 0,6989 lb/m

Ürün Kodu / Product Code	3104
Kalınlık / Thickness	1 mm
Ağırlık / Weight	0,469 kg/m 1,034 lb/m

Ürün Kodu / Product Code	2645
Kalınlık / Thickness	1,1 mm
Ağırlık / Weight	0,328 kg/m 0,7231 lb/m

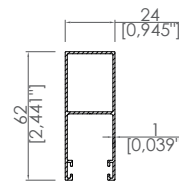
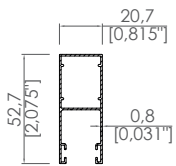

Ürün Kodu / Product Code	2501
Kalınlık / Thickness	0,8 mm
Ağırlık / Weight	0,366 kg/m 0,8069 lb/m

Ürün Kodu / Product Code	2500
Kalınlık / Thickness	1 mm
Ağırlık / Weight	0,505 kg/m 1,1133 lb/m

Ürün Kodu / Product Code	2498
Kalınlık / Thickness	1 mm
Ağırlık / Weight	0,331 kg/m 0,7297 lb/m

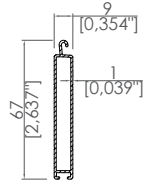

Ürün Kodu / Product Code	2497
Kalınlık / Thickness	1 mm
Ağırlık / Weight	0,402 kg/m 0,8863 lb/m

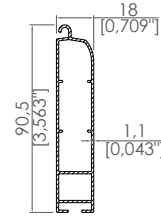

Ürün Kodu / Product Code	2444
Kalınlık / Thickness	1,1 mm
Ağırlık / Weight	0,716 kg/m 1,5785 lb/m

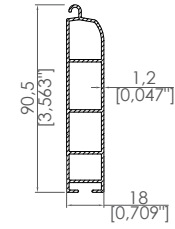

Ürün Kodu / Product Code	2199
Kalınlık / Thickness	1,2 mm
Ağırlık / Weight	0,851 kg/m 1,876 lb/m

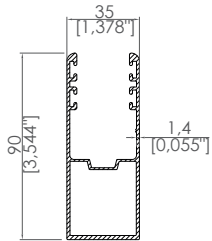

Ürün Kodu / Product Code	2652
Kalınlık / Thickness	1,4 mm
Ağırlık / Weight	1,177 kg/m 2,595 lb/m

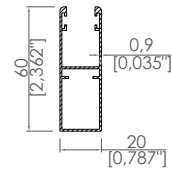

Ürün Kodu / Product Code	2651
Kalınlık / Thickness	0,9 mm
Ağırlık / Weight	0,456 kg/m 1,0053 lb/m

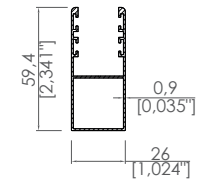

Ürün Kodu / Product Code	2650
Kalınlık / Thickness	0,9 mm
Ağırlık / Weight	0,518 kg/m 1,142 lb/m

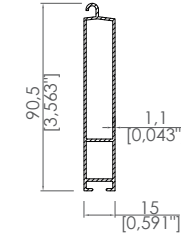
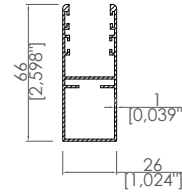
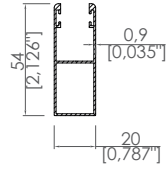

Ürün Kodu / Product Code	2649
Kalınlık / Thickness	0,9 mm
Ağırlık / Weight	0,412 kg/m 0,9083 lb/m

Ürün Kodu / Product Code	2648
Kalınlık / Thickness	1 mm
Ağırlık / Weight	0,632 kg/m 1,3933 lb/m

Ürün Kodu / Product Code	2647
Kalınlık / Thickness	1,1 mm
Ağırlık / Weight	0,675 kg/m 1,488 lb/m

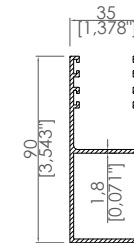
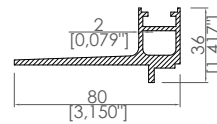
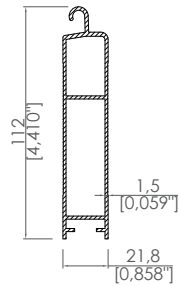

Ürün Kodu / Product Code	2646
Kalınlık / Thickness	1,5 mm
Ağırlık / Weight	1,136 kg/m 2,5045 lb/m

Ürün Kodu / Product Code	35020
Kalınlık / Thickness	2 mm
Ağırlık / Weight	1,285 kg/m 2,833 lb/m

Ürün Kodu / Product Code	35019
Kalınlık / Thickness	1,8 mm
Ağırlık / Weight	1,317 kg/m 2,9035 lb/m

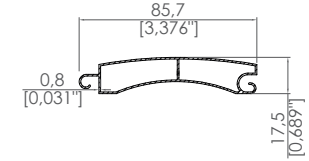
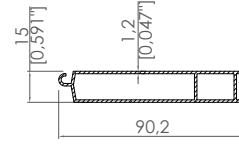
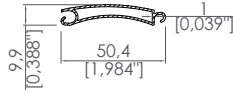

Ürün Kodu / Product Code	3337
Kalınlık / Thickness	1 mm
Ağırlık / Weight	0,314 kg/m 0,6923 lb/m

Ürün Kodu / Product Code	35018
Kalınlık / Thickness	1,2 mm
Ağırlık / Weight	0,720 kg/m 1,5873 lb/m

Ürün Kodu / Product Code	35017
Kalınlık / Thickness	0,8 mm
Ağırlık / Weight	0,480 kg/m 1,0582 lb/m

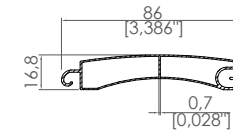
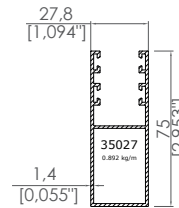
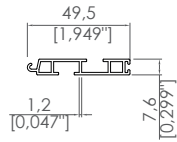

Ürün Kodu / Product Code	3372
Kalınlık / Thickness	1,2 mm
Ağırlık / Weight	0,350 kg/m 0,7716 lb/m

Ürün Kodu / Product Code	35027
Kalınlık / Thickness	1,4 mm
Ağırlık / Weight	0,892 kg/m 1,9665 lb/m

Ürün Kodu / Product Code	35027
Kalınlık / Thickness	0,7 mm
Ağırlık / Weight	0,470 kg/m 1,0362 lb/m

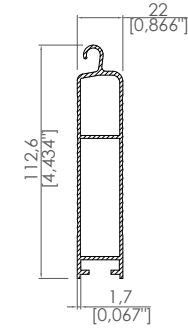
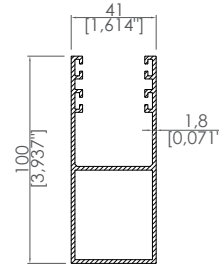
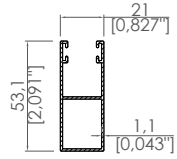

Ürün Kodu / Product Code	35024
Kalınlık / Thickness	1,1 mm
Ağırlık / Weight	1,703 kg/m 3,7545 lb/m

Ürün Kodu / Product Code	2197
Kalınlık / Thickness	1,8 mm
Ağırlık / Weight	1,537 kg/m 3,3885 lb/m

Ürün Kodu / Product Code	2196
Kalınlık / Thickness	1,7 mm
Ağırlık / Weight	1,133 kg/m 2,4537 lb/m

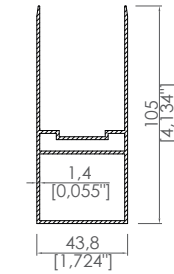
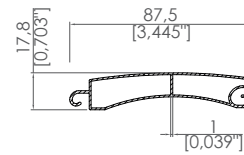
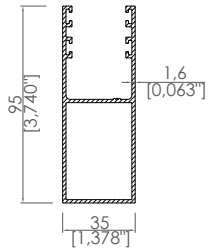

Ürün Kodu / Product Code	2140
Kalınlık / Thickness	1,6 mm
Ağırlık / Weight	1,244 kg/m 2,7426 lb/m

Ürün Kodu / Product Code	37076
Kalınlık / Thickness	1 mm
Ağırlık / Weight	0,569 kg/m 1,2544 lb/m

Ürün Kodu / Product Code	37052
Kalınlık / Thickness	1,4 mm
Ağırlık / Weight	1,276 kg/m 2,813 lb/m

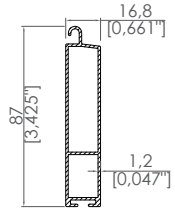

Ürün Kodu / Product Code	2143
Kalınlık / Thickness	1,2 mm
Ağırlık / Weight	0,734 kg/m 1,6182 lb/m

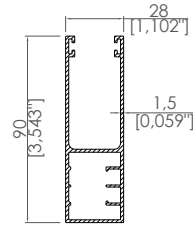

Ürün Kodu / Product Code	2142
Kalınlık / Thickness	1,5 mm
Ağırlık / Weight	1,070 kg/m 2,359 lb/m

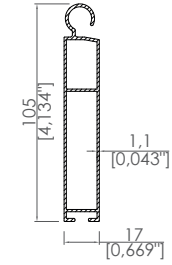

Ürün Kodu / Product Code	35028
Kalınlık / Thickness	1,1 mm
Ağırlık / Weight	0,829 kg/m 1,8276 lb/m

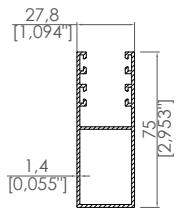

Ürün Kodu / Product Code	35027
Kalınlık / Thickness	1,4 mm
Ağırlık / Weight	0,892 kg/m 1,9665 lb/m

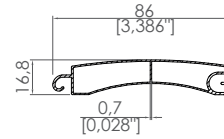

Ürün Kodu / Product Code	35025
Kalınlık / Thickness	0,7 mm
Ağırlık / Weight	0,470 kg/m 1,0362 lb/m

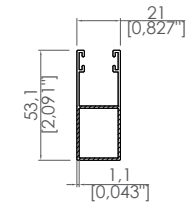

Ürün Kodu / Product Code	35024
Kalınlık / Thickness	1,1 mm
Ağırlık / Weight	1,703 kg/m 3,7545 lb/m

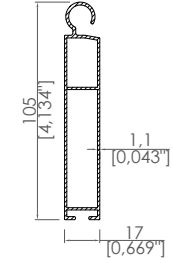

Ürün Kodu / Product Code	35028
Kalınlık / Thickness	1,1 mm
Ağırlık / Weight	0,829 kg/m 1,8276 lb/m

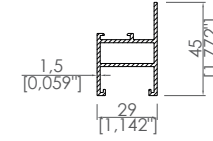

Ürün Kodu / Product Code	3120
Kalınlık / Thickness	1,5 mm
Ağırlık / Weight	0,566 kg/m 1,2478 lb/m

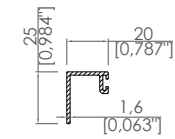
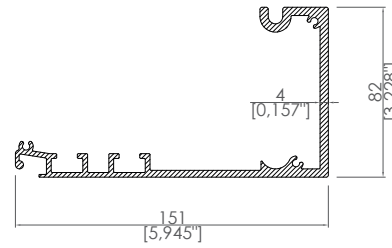
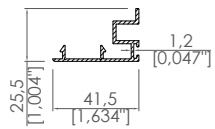

Ürün Kodu / Product Code	3121
Kalınlık / Thickness	1,2 mm
Ağırlık / Weight	0,371 kg/m 0,8179 lb/m

Ürün Kodu / Product Code	3114
Kalınlık / Thickness	4 mm
Ağırlık / Weight	3,054 kg/m 6,733 lb/m

Ürün Kodu / Product Code	3119
Kalınlık / Thickness	1,6 mm
Ağırlık / Weight	0,244 kg/m 0,5379 lb/m

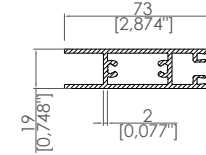
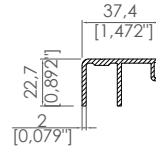
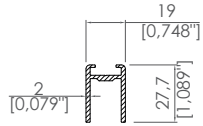

Ürün Kodu / Product Code	3118
Kalınlık / Thickness	2 mm
Ağırlık / Weight	0,398 kg/m 0,8774 lb/m

Ürün Kodu / Product Code	3117
Kalınlık / Thickness	2 mm
Ağırlık / Weight	0,496 kg/m 1,0935 lb/m

Ürün Kodu / Product Code	3116
Kalınlık / Thickness	2 mm
Ağırlık / Weight	1,108 kg/m 2,4427 lb/m

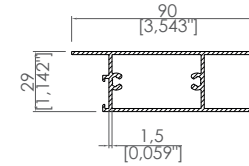
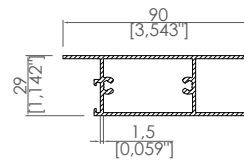
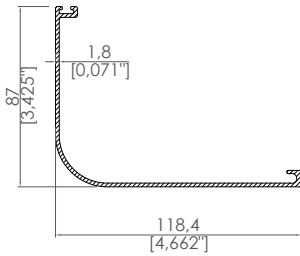

Ürün Kodu / Product Code	3115
Kalınlık / Thickness	1,8 mm
Ağırlık / Weight	1,070 kg/m 2,359 lb/m

Ürün Kodu / Product Code	3123
Kalınlık / Thickness	1,5 mm
Ağırlık / Weight	1,068 kg/m 2,3545 lb/m

Ürün Kodu / Product Code	3122
Kalınlık / Thickness	1,5 mm
Ağırlık / Weight	1,008 kg/m 2,2223 lb/m

TENTE PROFİLLERİ
AWNING PROFILES



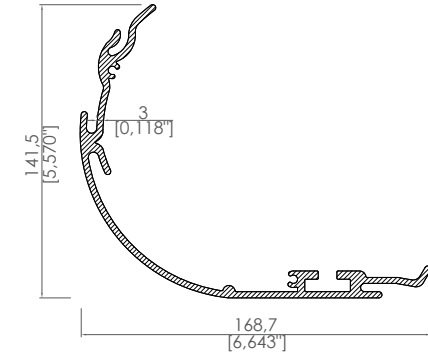
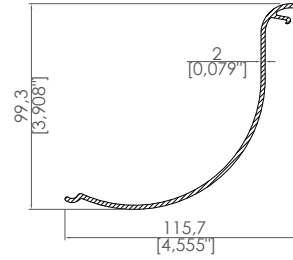
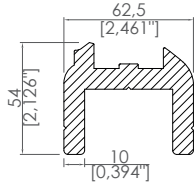

Ürün Kodu / Product Code	4366
Kalınlık / Thickness	10 mm
Ağırlık / Weight	3,875 kg/m 8,5429 lb/m

Ürün Kodu / Product Code	4368
Kalınlık / Thickness	2 mm
Ağırlık / Weight	1,035 kg/m 2,2817 lb/m

Ürün Kodu / Product Code	4370
Kalınlık / Thickness	3 mm
Ağırlık / Weight	3,512 kg/m 7,9454 lb/m

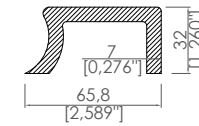
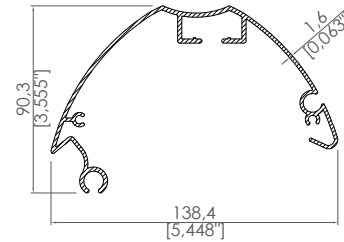
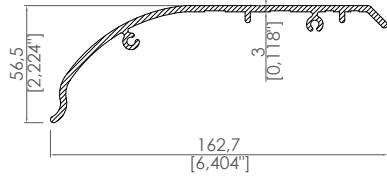

Ürün Kodu / Product Code	4367
Kalınlık / Thickness	3 mm
Ağırlık / Weight	1,797 kg/m 3,9595 lb/m

Ürün Kodu / Product Code	4369
Kalınlık / Thickness	1,6 mm
Ağırlık / Weight	1,735 kg/m 3,825 lb/m

Ürün Kodu / Product Code	4373
Kalınlık / Thickness	7 mm
Ağırlık / Weight	0,406 kg/m 0,895 lb/m

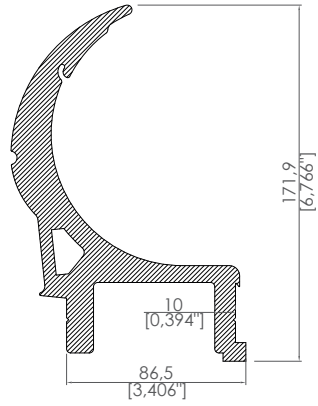

Ürün Kodu / Product Code	4371
Kalınlık / Thickness	10 mm
Ağırlık / Weight	10,975 kg/m 24,196 lb/m

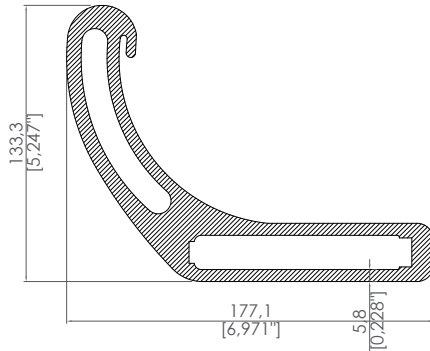

Ürün Kodu / Product Code	4372
Kalınlık / Thickness	5,8 mm
Ağırlık / Weight	10,731 kg/m 23,657 lb/m



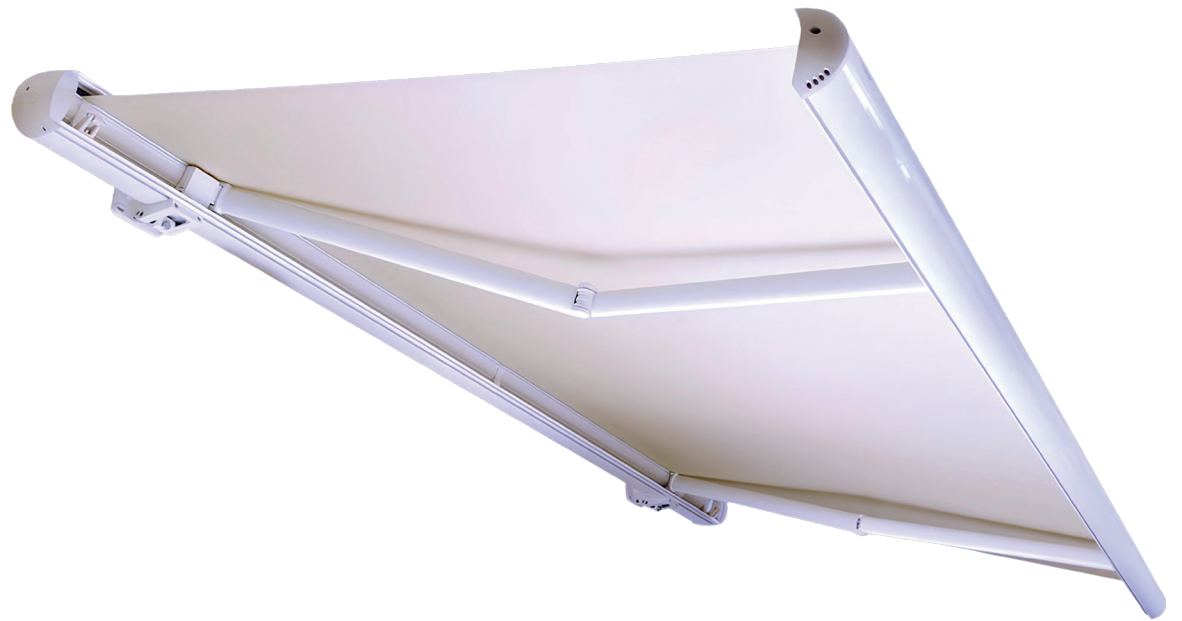



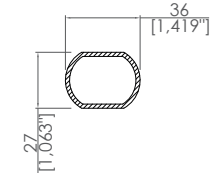
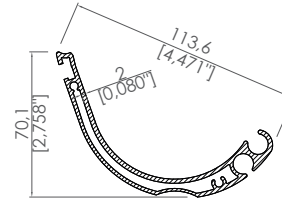

Ürün Kodu / Product Code	6244
Kalınlık / Thickness	2 mm
Ağırlık / Weight	1,645 kg/m 3,6376 lb/m

Ürün Kodu / Product Code	6246
Kalınlık / Thickness	2 mm
Ağırlık / Weight	0,542 kg/m 1,195 lb/m

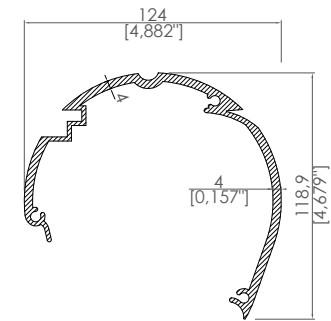
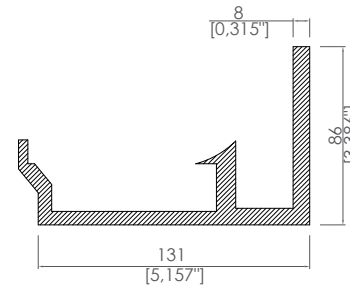

Ürün Kodu / Product Code	6312
Kalınlık / Thickness	8 mm
Ağırlık / Weight	5,596 kg/m 12,337 lb/m

Ürün Kodu / Product Code	6245
Kalınlık / Thickness	4 mm
Ağırlık / Weight	3,060 kg/m 6,746 lb/m

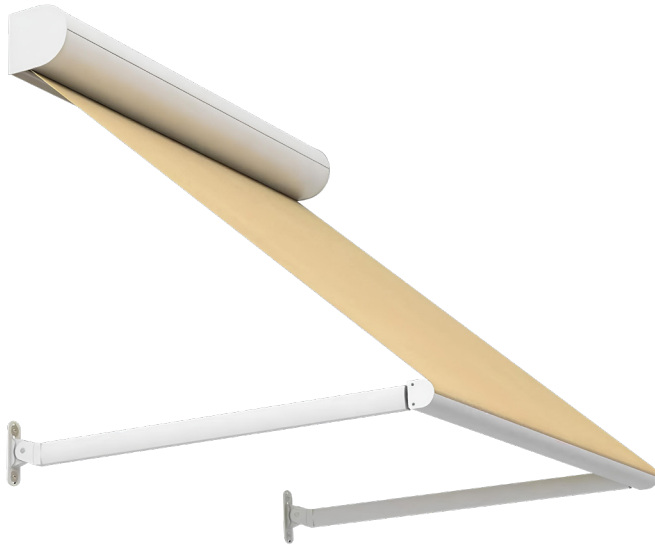

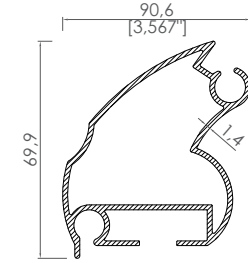
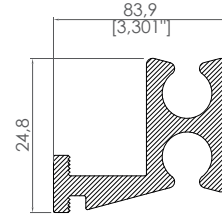
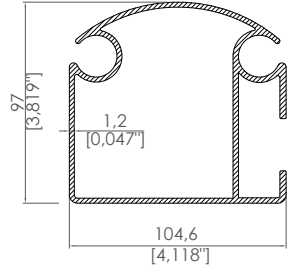

Ürün Kodu / Product Code	5315
Kalınlık / Thickness	1,2 mm
Ağırlık / Weight	0,811 kg/m 1,788 lb/m

Ürün Kodu / Product Code	5385
Kalınlık / Thickness	3,2 mm
Ağırlık / Weight	0,623 kg/m 1,373 lb/m

Ürün Kodu / Product Code	5465
Kalınlık / Thickness	1,4 mm
Ağırlık / Weight	1,150 kg/m 2,5353 lb/m



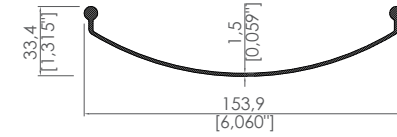
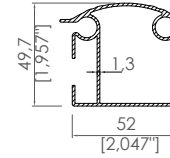
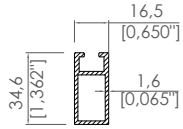

Ürün Kodu / Product Code	37093
Kalınlık / Thickness	1,6 mm
Ağırlık / Weight	0,488 kg/m 1,0759 lb/m

Ürün Kodu / Product Code	0040
Kalınlık / Thickness	1,3 mm
Ağırlık / Weight	0,925 kg/m 2,0393 lb/m

Ürün Kodu / Product Code	5386
Kalınlık / Thickness	1,5 mm
Ağırlık / Weight	0,872 kg/m 1,9224 lb/m

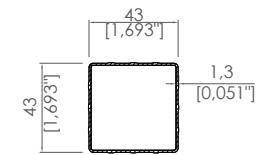
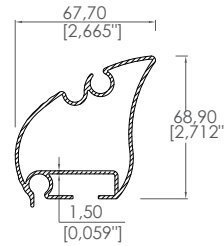
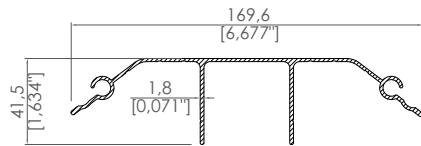

Ürün Kodu / Product Code	1887
Kalınlık / Thickness	1,8 mm
Ağırlık / Weight	1,314 kg/m 2,897 lb/m

Ürün Kodu / Product Code	0041
Kalınlık / Thickness	1,5 mm
Ağırlık / Weight	1,269 kg/m 2,7977 lb/m

Ürün Kodu / Product Code	0039
Kalınlık / Thickness	1,3mm
Ağırlık / Weight	0,475 kg/m 1,0472 lb/m

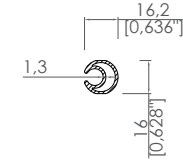
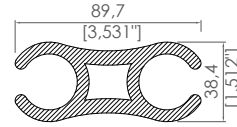
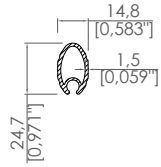

Ürün Kodu / Product Code	0042
Kalınlık / Thickness	1,5 mm
Ağırlık / Weight	0,281 kg/m 0,6195 lb/m

Ürün Kodu / Product Code	37184
Kalınlık / Thickness	6,9 mm
Ağırlık / Weight	0,425 kg/m 0,937 lb/m

Ürün Kodu / Product Code	5377
Kalınlık / Thickness	1,3 mm
Ağırlık / Weight	0,228 kg/m 0,5027 lb/m

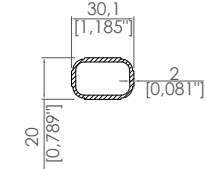
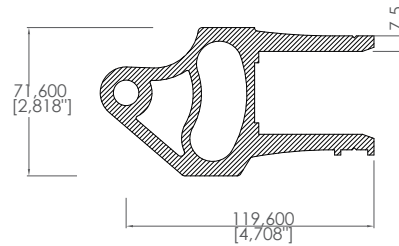
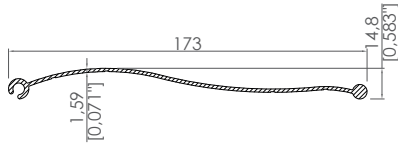

Ürün Kodu / Product Code	1888
Kalınlık / Thickness	1,59 mm
Ağırlık / Weight	0,903 kg/m 1,9908 lb/m

Ürün Kodu / Product Code	0080
Kalınlık / Thickness	7,5 mm
Ağırlık / Weight	7,433 kg/m 16,387 lb/m

Ürün Kodu / Product Code	0053
Kalınlık / Thickness	2 mm
Ağırlık / Weight	0,396 kg/m 0,873 lb/m





Part of **KENAN METAL**

Architecture profile systems



PERGOLA SİSTEMLERİ
PERGOLA SYSTEMS

Eğimli ve Oval Pergola Sistemleri
Inclined and Curved Pergola Systems



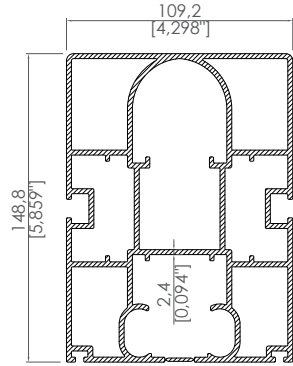

110x150 Ray
110x150 Rail Profile

Ürün Kodu / Product Code	2001
Kalınlık / Thickness	2,4 mm
Ağırlık / Weight	7,168 kg/m 15,803 lb/m

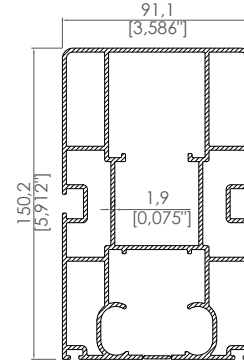

90x150 Ray
90x150 Rail Profile

Ürün Kodu / Product Code	2052
Kalınlık / Thickness	1,9 mm
Ağırlık / Weight	5,217 kg/m 11,502 lb/m

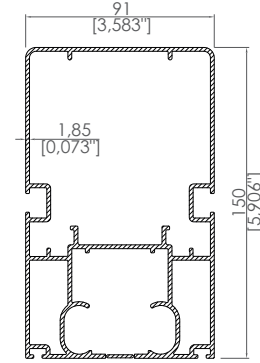

90x150 Eko Ray
90x150 Eco Rail Profile

Ürün Kodu / Product Code	2932
Kalınlık / Thickness	1,85 mm
Ağırlık / Weight	3,984 kg/m 8,783 lb/m

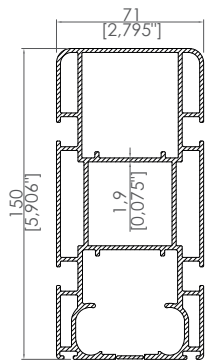

70x150 Ray
70x150 Rail Profile

Ürün Kodu / Product Code	6413
Kalınlık / Thickness	1,9 mm
Ağırlık / Weight	4,655 kg/m 10,263 lb/m

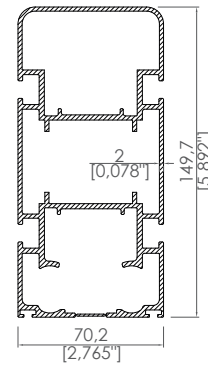

70x150 Ray
70x150 Rail Profile

Ürün Kodu / Product Code	5922
Kalınlık / Thickness	2 mm
Ağırlık / Weight	4,212 kg/m 9,286 lb/m

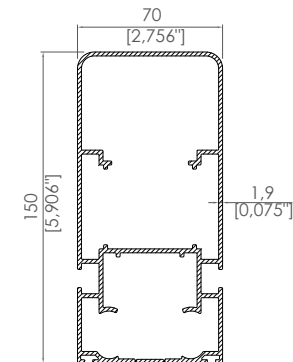

70x150 Eko Ray
70x150 Eco Rail Profile

Ürün Kodu / Product Code	2156
Kalınlık / Thickness	1,9 mm
Ağırlık / Weight	3,217 kg/m 7,092 lb/m

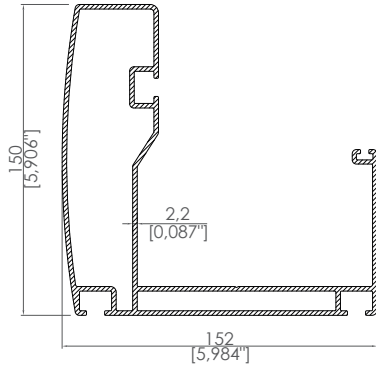

152x150 Dere
152X150 Gutter

Ürün Kodu / Product Code	2078
Kalınlık / Thickness	2,2 mm
Ağırlık / Weight	4,398 kg/m 9,696 lb/m

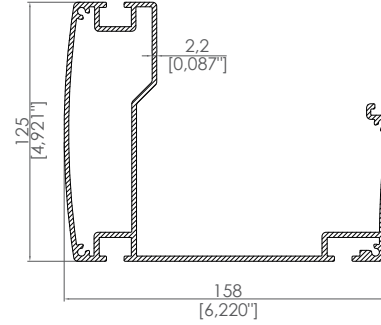

158X125 Dere
158X125 Gutter

Ürün Kodu / Product Code	5935
Kalınlık / Thickness	2,2 mm
Ağırlık / Weight	3,916 kg/m 8,633 lb/m

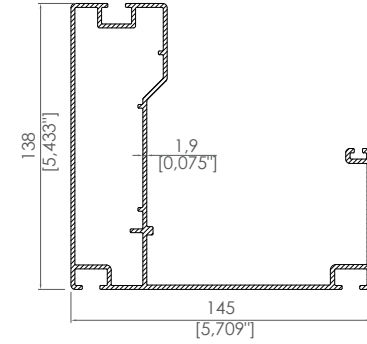

138x145 Eko Dere
138X145 Eco Gutter

Ürün Kodu / Product Code	3263
Kalınlık / Thickness	1,9 mm
Ağırlık / Weight	3,320 kg/m 7,32 lb/m

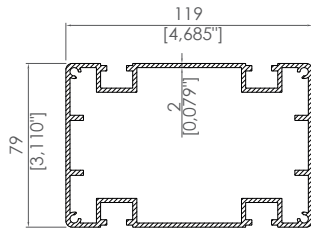

Yatay Profil
Side Profile

Ürün Kodu / Product Code	5936
Kalınlık / Thickness	2 mm
Ağırlık / Weight	3,032 kg/m 6,684 lb/m

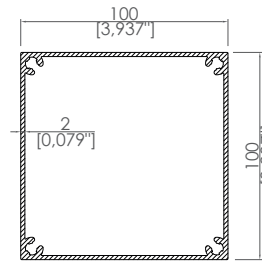

100x100 Dikme
100x100 Pillar

Ürün Kodu / Product Code	6565
Kalınlık / Thickness	2 mm
Ağırlık / Weight	2,463 kg/m 5,43 lb/m

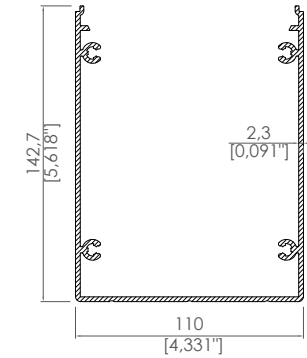

110x145 Dikme Gövde
110x145 Pillar Main Profile

Ürün Kodu / Product Code	2301
Kalınlık / Thickness	2,3 mm
Ağırlık / Weight	3,003 kg/m 6,62 lb/m

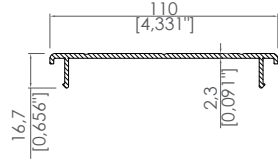

110x145 Dikme Kapak
110x145 Pillar Cover Profile

Ürün Kodu / Product Code	2302
Kalınlık / Thickness	2,3 mm
Ağırlık / Weight	0,846 kg/m 1,865 lb/m

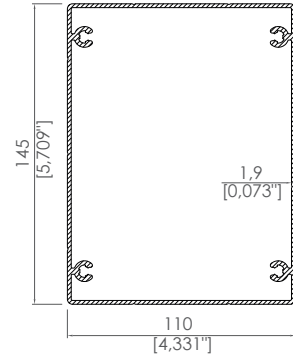

110x145 Dikme
110x145 Pillar

Ürün Kodu / Product Code	2111
Kalınlık / Thickness	1,9 mm
Ağırlık / Weight	3,044 kg/m 6,711 lb/m

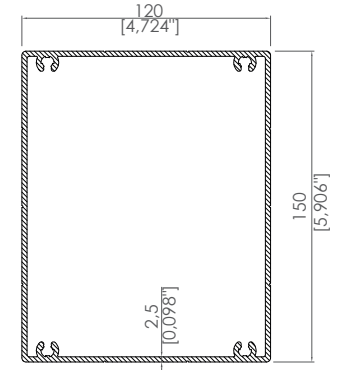

120x150 Dikme
120x150 Pillar

Ürün Kodu / Product Code	6569
Kalınlık / Thickness	2,5 mm
Ağırlık / Weight	3,994 kg/m 8,805 lb/m

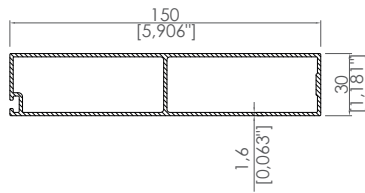

30x150 Kutu Profil
30x150 Box Profile

Ürün Kodu / Product Code	37025
Kalınlık / Thickness	1,6 mm
Ağırlık / Weight	1,711 kg/m 3,785 lb/m

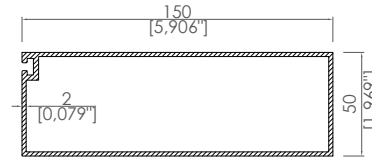

50x150 Kutu Profil
50x150 Box Profile

Ürün Kodu / Product Code	1517
Kalınlık / Thickness	2 mm
Ağırlık / Weight	2,217 kg/m 4,888 lb/m

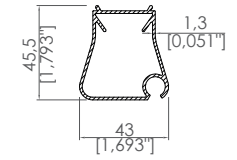

43x45,5 Kumaş Profili
43x45,5 Fabric Support Profile

Ürün Kodu / Product Code	3370
Kalınlık / Thickness	1,3 mm
Ağırlık / Weight	0,667 kg/m 1,4705 lb/m

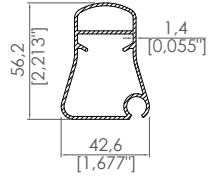

42,6x56,2 Kumaş Profili
42,6x56,2 Fabric Support Profile

Ürün Kodu / Product Code	37156
Kalınlık / Thickness	1,4 mm
Ağırlık / Weight	0,845 kg/m 1,863 lb/m

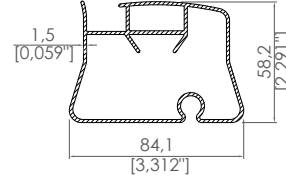

84,1x58,2 Kumaş Profili
84,1x58,2 Fabric Support Profile

Ürün Kodu / Product Code	37200
Kalınlık / Thickness	1,5 mm
Ağırlık / Weight	1,510 kg/m 3,329 lb/m

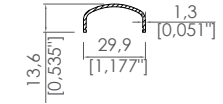

Kumaş Profili Kapağı
Fabric Support Profile Cover

Ürün Kodu / Product Code	37034
Kalınlık / Thickness	1,3 mm
Ağırlık / Weight	0,163 kg/m 0,35935 lb/m

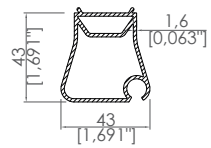

43x43 Kumaş Profili
43x43 Fabric Support Profile

Ürün Kodu / Product Code	37033
Kalınlık / Thickness	1,6 mm
Ağırlık / Weight	0,882 kg/m 1,9445 lb/m

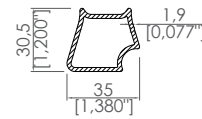

35x30,5 Kumaş Profili Eki
35x30,5 Fabric Support Connection Profile

Ürün Kodu / Product Code	5477
Kalınlık / Thickness	1,9 mm
Ağırlık / Weight	0,616 kg/m 1,358 lb/m

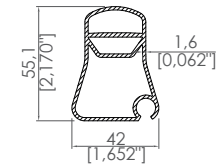

42x55,1 Kumaş Profili
42x55,1 Fabric Support Profile

Ürün Kodu / Product Code	5261
Kalınlık / Thickness	1,6 mm
Ağırlık / Weight	1,100 kg/m 2,425 lb/m

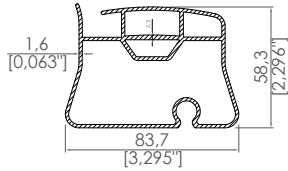

83,7x58,3 Kumaş Profili
83,7x58,3 Fabric Support Profile

Ürün Kodu / Product Code	5410
Kalınlık / Thickness	1,6 mm
Ağırlık / Weight	1,830 kg/m 4,0345 lb/m

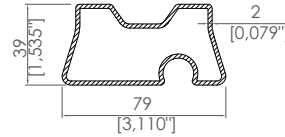

79x39 Kumaş Profili Eki
79x39 Fabric Support Profile Connection

Ürün Kodu / Product Code	5478
Kalınlık / Thickness	2 mm
Ağırlık / Weight	1,309 kg/m 2,886 lb/m

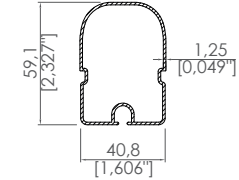

40,8x59,1 Kumaş Profili
40,8x59,1 Fabric Support Profile

Ürün Kodu / Product Code	2653
Kalınlık / Thickness	1,2 mm
Ağırlık / Weight	0,697 kg/m 1,5366 lb/m

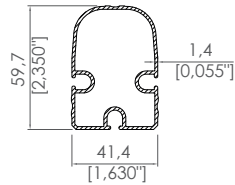

41,4x 59,7 Kumaş Profili
41,4x 59,7 Fabric Support Profile

Ürün Kodu / Product Code	37153
Kalınlık / Thickness	1,4 mm
Ağırlık / Weight	0,937 kg/m 2,0657 lb/m

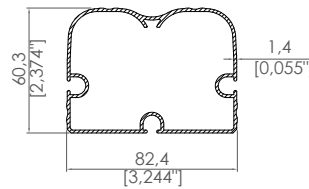

82,4x60,3 Kumaş Profili
82,4x60,3 Fabric Support Profile

Ürün Kodu / Product Code	37216
Kalınlık / Thickness	1,4 mm
Ağırlık / Weight	1,280 kg/m 2,822 lb/m

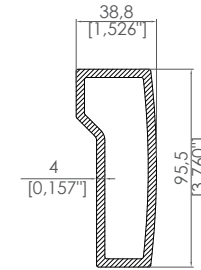

38,8x95,5 Dere Eki Profili
38,8x95,5 Gutter Profile Connection

Ürün Kodu / Product Code	6536
Kalınlık / Thickness	4 mm
Ağırlık / Weight	2,618 kg/m 5,772 lb/m

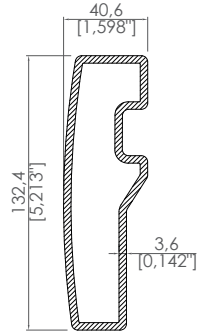

40,6X132,4 Dere Eki Profili
40,6X132,4 Gutter Profile Connection

Ürün Kodu / Product Code	2281
Kalınlık / Thickness	3,6 mm
Ağırlık / Weight	3,246 kg/m 7,156 lb/m

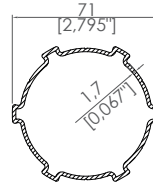

Motor Borusu Eki
Motor Tube Connection

Ürün Kodu / Product Code	37100
Kalınlık / Thickness	1,7 mm
Ağırlık / Weight	1,074 kg/m 2,368 lb/m

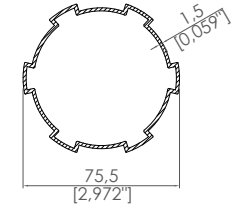

Motor Borusu
Motor Tube

Ürün Kodu / Product Code	5312
Kalınlık / Thickness	1,5 mm
Ağırlık / Weight	1,100 kg/m 2,425 lb/m

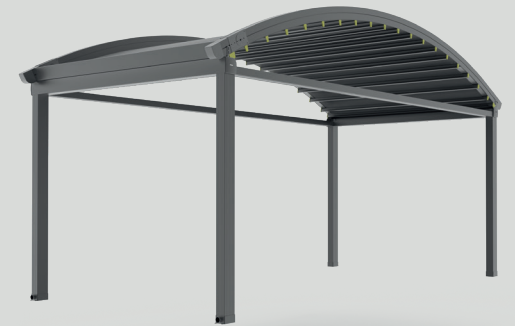
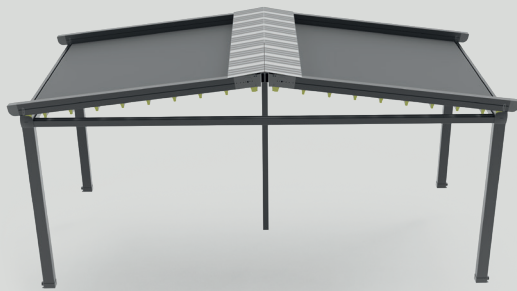

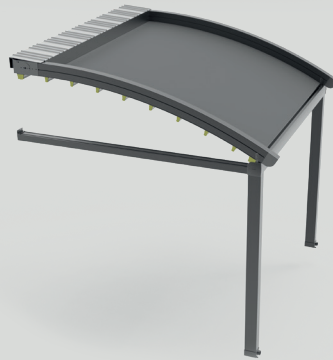
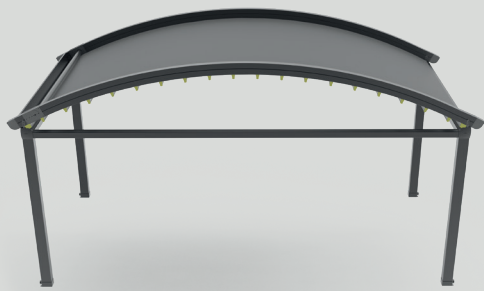
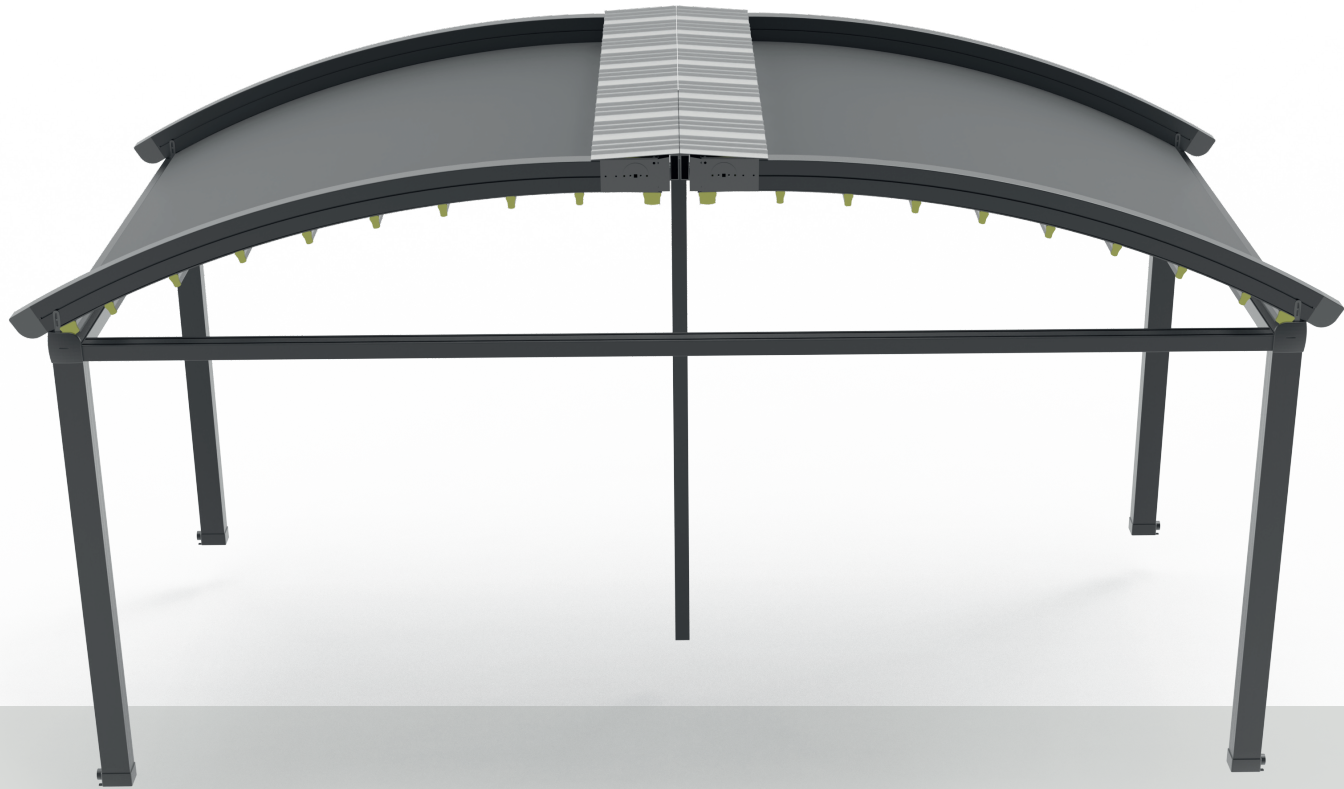

BİOKLİMATİK SİSTEMLERİ
BIOCLIMATIC SYSTEMS

Bio Per Bioklimatik
Bio Per Bioclimatic



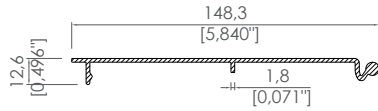

Motor Kutusu Kapağı
Motor Box Cover

Ürün Kodu / Product Code	2091
Kalınlık / Thickness	1,8 mm
Ağırlık / Weight	0,915 kg/m 2,0172 lb/m

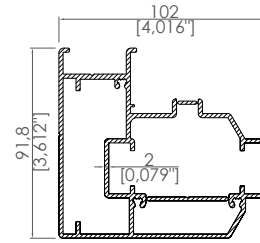

Ray Profili
Rail Profile

Ürün Kodu / Product Code	2279
Kalınlık / Thickness	2 mm
Ağırlık / Weight	3,056 kg/m 6,737 lb/m

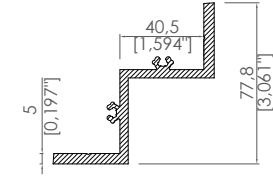

Köşe Birleştirici
Corner Connection Bracket

Ürün Kodu / Product Code	2119
Kalınlık / Thickness	5 mm
Ağırlık / Weight	1,987 kg/m 4,381 lb/m

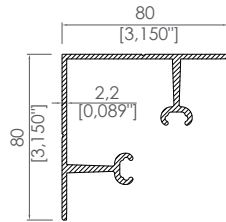

Köşe Birleştirici Kapağı
Corner Connection Cover

Ürün Kodu / Product Code	2118
Kalınlık / Thickness	2,2 mm
Ağırlık / Weight	1,692 kg/m 3,73 lb/m

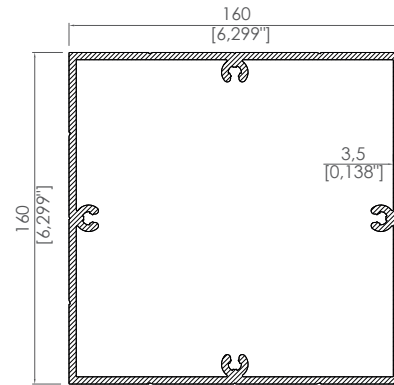

Çizgili Dikme Profili
Lined Pillar Profile

Ürün Kodu / Product Code	2087
Kalınlık / Thickness	3,5 mm
Ağırlık / Weight	6,822 kg/m 15,04 lb/m

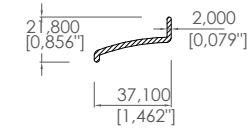

Motor Kutusu Ön Profil
Motor Box Front Profile

Ürün Kodu / Product Code	2092
Kalınlık / Thickness	2 mm
Ağırlık / Weight	0,326 kg/m 0,7187 lb/m

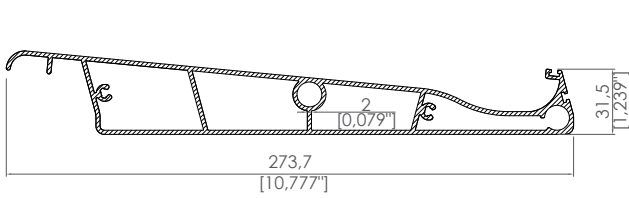

Panel Profili
Panel Profile

Ürün Kodu / Product Code	2096
Kalınlık / Thickness	2 mm
Ağırlık / Weight	3,962 kg/m 8,735 lb/m

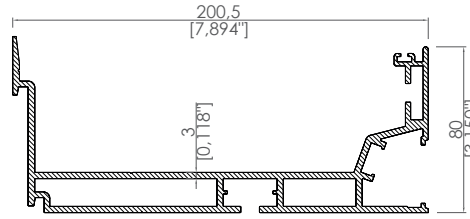

Dere Profili
Gutter Profile

Ürün Kodu / Product Code	2089
Kalınlık / Thickness	3 mm
Ağırlık / Weight	4,950 kg/m 10,913 lb/m

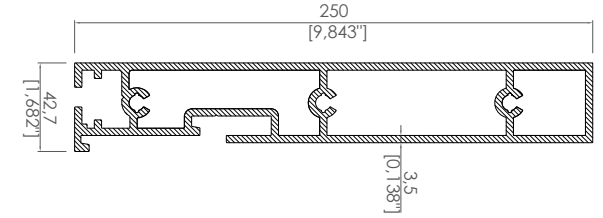

Yan Kayıt Profili
Side Beam Profile

Ürün Kodu / Product Code	2088
Kalınlık / Thickness	3,5 mm
Ağırlık / Weight	7,213 kg/m 15,902 lb/m

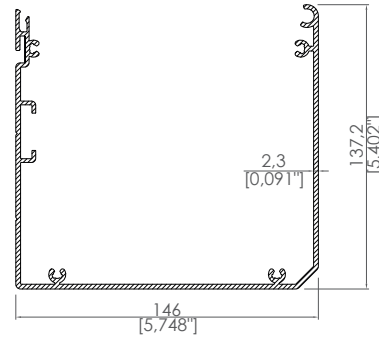
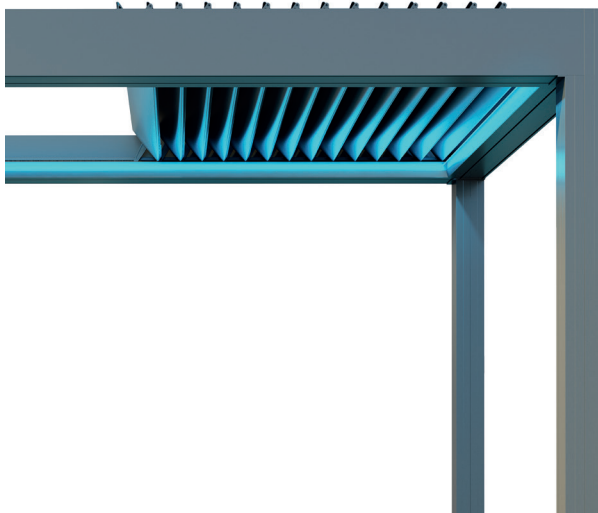

Motor Kutusu
Motor Box

Ürün Kodu / Product Code	2090
Kalınlık / Thickness	2,3 mm
Ağırlık / Weight	3,075 kg/m 6,779 lb/m

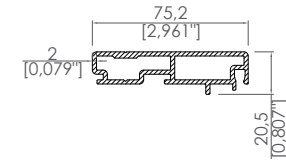

Ray Kapak Profili
Rail Cover Profile

Ürün Kodu / Product Code	2280
Kalınlık / Thickness	2 mm
Ağırlık / Weight	1,150 kg/m 2,5353 lb/m



BİOKLİMATİK SİSTEMLERİ
BIOCLIMATIC SYSTEMS

Palmera Bioklimatik
Palmera Bioclimatic



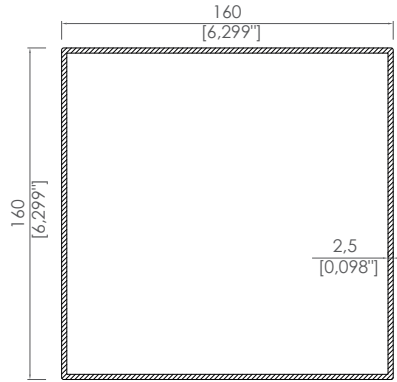

Dikme Profili
Pillar Profile

Ürün Kodu / Product Code	2426
Kalınlık / Thickness	2,5 mm
Ağırlık / Weight	4,270 kg/m 9,414 lb/m

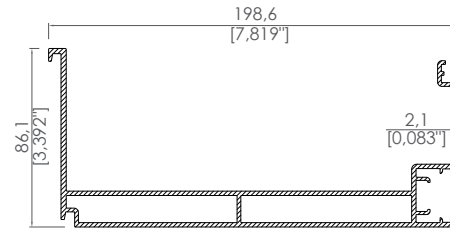

Dere Profili
Gutter Profile

Ürün Kodu / Product Code	2423
Kalınlık / Thickness	2,1 mm
Ağırlık / Weight	3,512 kg/m 7,743 lb/m

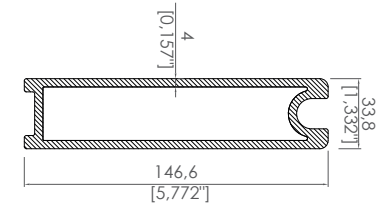

Yan Kayıt Bağlantı Profili
Side Beam Connection Profile

Ürün Kodu / Product Code	2425
Kalınlık / Thickness	4 mm
Ağırlık / Weight	4,082 kg/m 9 lb/m

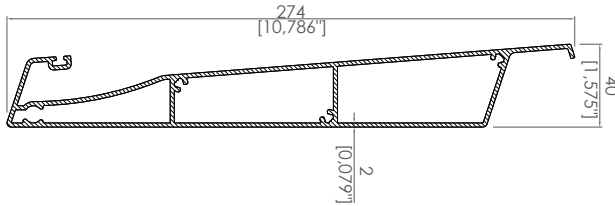

Panel Profili
Panel Profile

Ürün Kodu / Product Code	2420
Kalınlık / Thickness	2 mm
Ağırlık / Weight	3,700 kg/m 8,157 lb/m

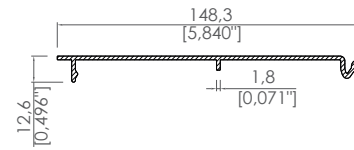

Motor Kutusu Kapağı
Motor Box Cover

Ürün Kodu / Product Code	2091
Kalınlık / Thickness	1,8 mm
Ağırlık / Weight	0,915 kg/m 2,0172 lb/m

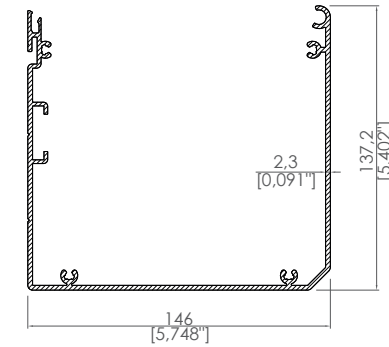

Motor Kutusu
Motor Box

Ürün Kodu / Product Code	2090
Kalınlık / Thickness	2,3 mm
Ağırlık / Weight	3,075 kg/m 6,779 lb/m

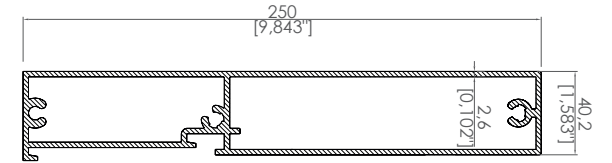
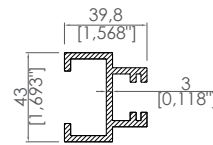
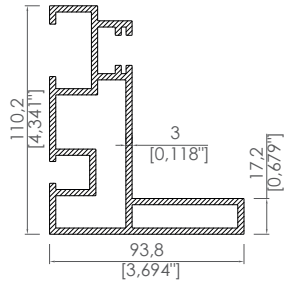
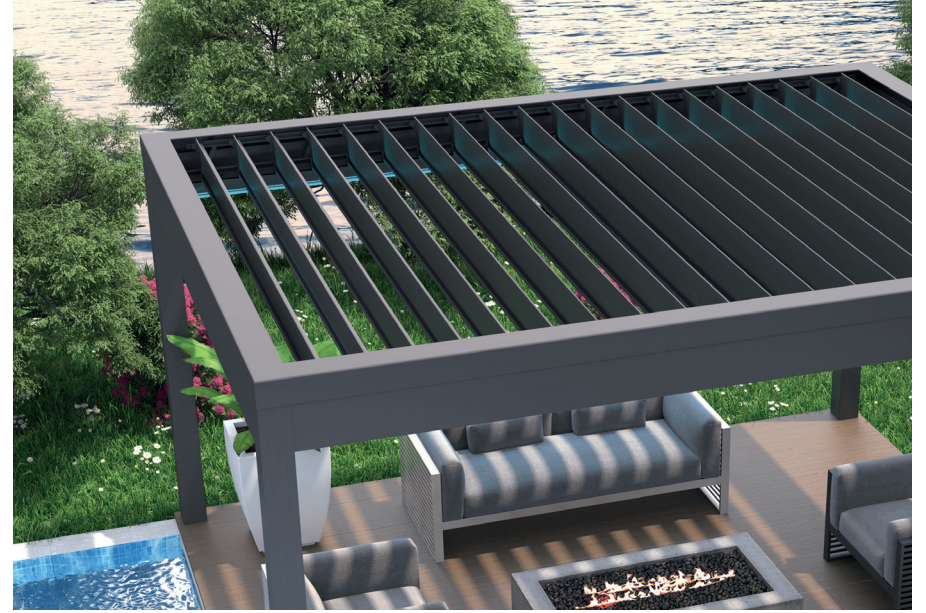

Ray Profili
Rail Profile

Ürün Kodu / Product Code	2422
Kalınlık / Thickness	3 mm
Ağırlık / Weight	3,933 kg/m 8,67 lb/m

Panel Üst Bağlantı Profili
Panel Top Connection Profile

Ürün Kodu / Product Code	2421
Kalınlık / Thickness	3 mm
Ağırlık / Weight	1,171 kg/m 2,5816 lb/m

Yan Kayıt Profili
Side Beam Profile

Ürün Kodu / Product Code	2424
Kalınlık / Thickness	2,6 mm
Ağırlık / Weight	4,990 kg/m 11 lb/m



BIOKLİMATİK SİSTEMLERİ
BIOCLIMATIC SYSTEMS

Lavin Bioklimatik
Lavin Bioclimatic



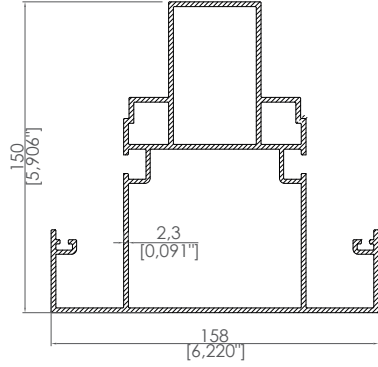

Orta Taşıyıcı Profili
Middle Beam Profile

Ürün Kodu / Product Code	3217
Kalınlık / Thickness	2,3 mm
Ağırlık / Weight	4,943 kg/m 10,897 lb/m

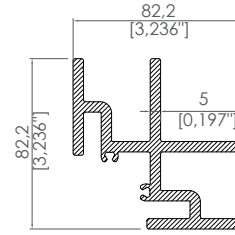

Köşe Takoz Profili
Corner Connection Bracket

Ürün Kodu / Product Code	3222
Kalınlık / Thickness	5 mm
Ağırlık / Weight	3,875 kg/m 8,543 lb/m

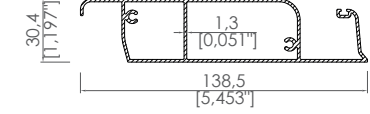

Panel Profili
Panel Profile

Ürün Kodu / Product Code	3224
Kalınlık / Thickness	1,3 mm
Ağırlık / Weight	1,328 kg/m 2,928 lb/m

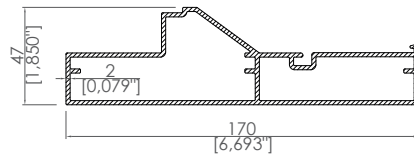

Yan Taşıyıcı Profili
Side Beam Profile

Ürün Kodu / Product Code	3218
Kalınlık / Thickness	2 mm
Ağırlık / Weight	2,558 kg/m 5,639 lb/m

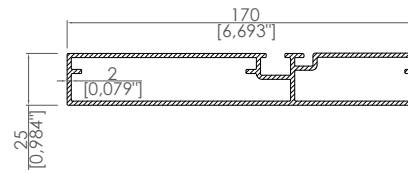

Ön Taşıyıcı Profili
Front Beam Profile

Ürün Kodu / Product Code	3219
Kalınlık / Thickness	2 mm
Ağırlık / Weight	2,434 kg/m 5,366 lb/m

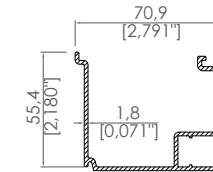

Dere Profili
Gutter Profile

Ürün Kodu / Product Code	3221
Kalınlık / Thickness	1,8 mm
Ağırlık / Weight	1,111 kg/m 2,4493 lb/m

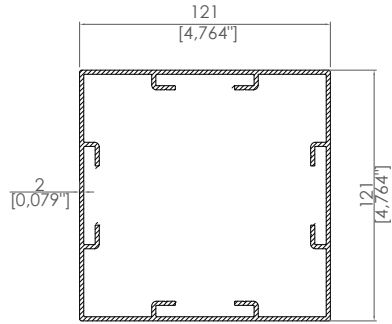

Direk Ayak Profili
Pillar Profile

Ürün Kodu / Product Code	3220
Kalınlık / Thickness	2 mm
Ağırlık / Weight	3,284 kg/m 7,239 lb/m

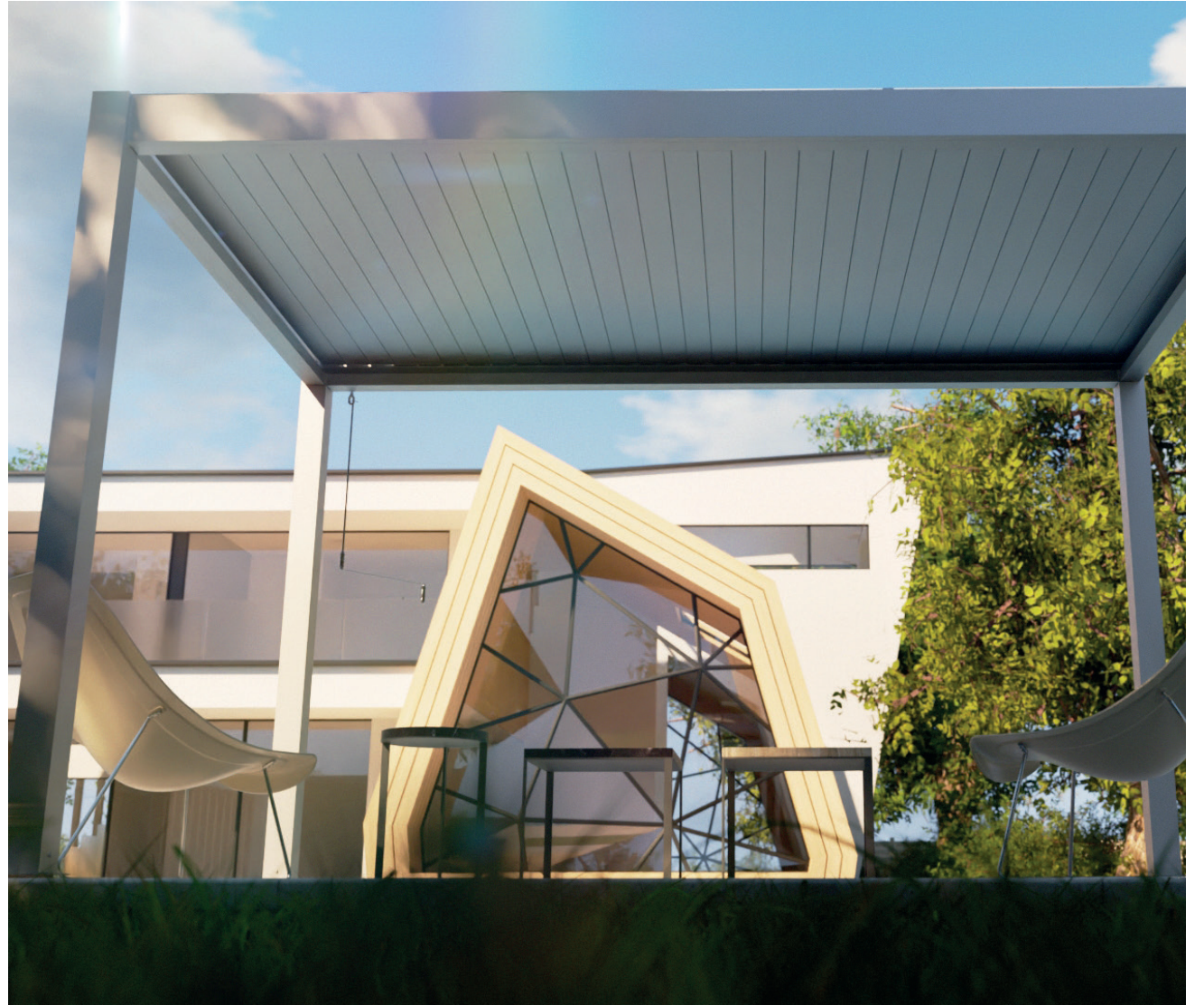
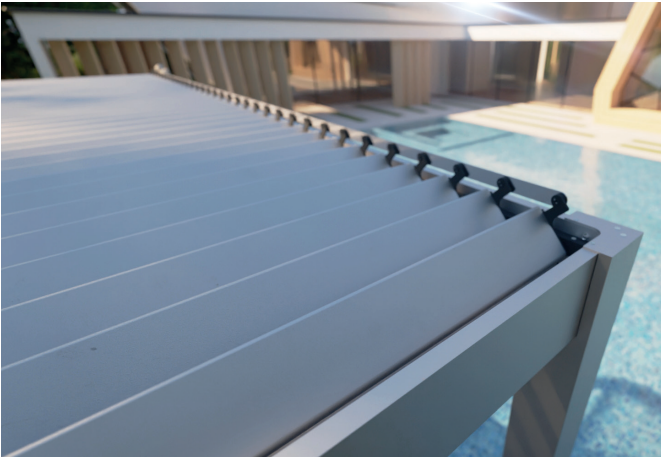



BIOKLİMATİK SİSTEMLERİ
BIOCLIMATIC SYSTEMS

Cabana Bioklimatik
Cabana Bioclimatic



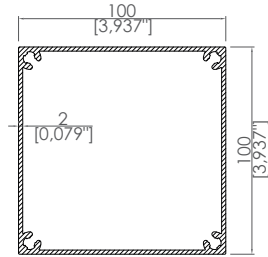

100x100 Dikme
 100x100 Pillar

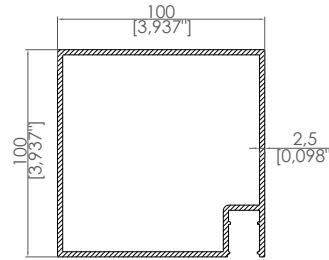
Ürün Kodu / Product Code	6565
Kalınlık / Thickness	2 mm
Ağırlık / Weight	2,463 kg/m 5,43 lb/m

Kayıt Profili
 Beam Profile

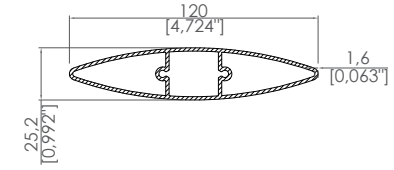
Ürün Kodu / Product Code	3325
Kalınlık / Thickness	2,5 mm
Ağırlık / Weight	2,799 kg/m 6,171 lb/m

Sun Breaker Profile
 Güneş Kırıcı Profili

Ürün Kodu / Product Code	37106
Kalınlık / Thickness	1,6 mm
Ağırlık / Weight	1,325 kg/m 2,921 lb/m

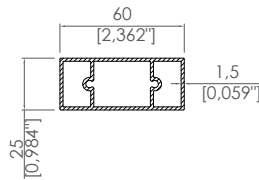
Kutu Profili
 Box Profile

Ürün Kodu / Product Code	3324
Kalınlık / Thickness	1,5 mm
Ağırlık / Weight	0,894 kg/m 1,971 lb/m

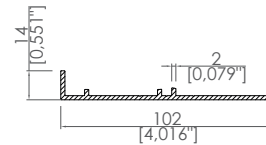
Panel Kayıt Bağlantı Profili
 Panel - Beam Connection Profile

Ürün Kodu / Product Code	3323
Kalınlık / Thickness	2 mm
Ağırlık / Weight	0,686 kg/m 1,5124 lb/m

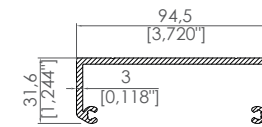

Kayıt Bağlantı Aparatı
 Beam Connection Bracket

Ürün Kodu / Product Code	3322
Kalınlık / Thickness	3 mm
Ağırlık / Weight	3,720 kg/m 8,201 lb/m

ROLLING ROOF SİSTEMLERİ
ROLLING ROOF SYSTEMS

Rolling Roof Profilleri
Rolling Roof Profiles

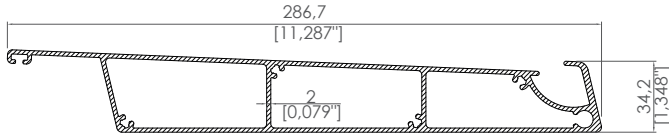



Panel Profili
Panel Profile

Ürün Kodu / Product Code	2340
Kalınlık / Thickness	2 mm
Ağırlık / Weight	3,986 kg/m 8,788 lb/m

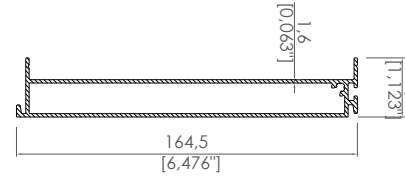

Dere Uzatma Profili
Gutter Extension Profile

Ürün Kodu / Product Code	2338
Kalınlık / Thickness	1,6 mm
Ağırlık / Weight	1,730 kg/m 3,814 lb/m

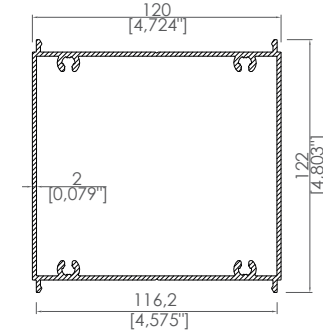

Dikme Profili
Pillar Profile

Ürün Kodu / Product Code	2341
Kalınlık / Thickness	2 mm
Ağırlık / Weight	3,028 kg/m 6,676 lb/m

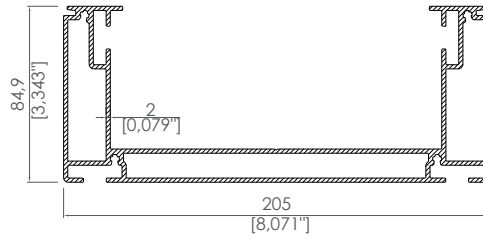

Dere Profili
Gutter Profile

Ürün Kodu / Product Code	2337
Kalınlık / Thickness	2 mm
Ağırlık / Weight	4,560 kg/m 10,053 lb/m

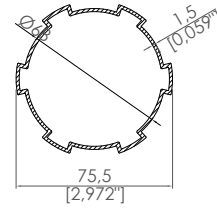

Motor Borusu
Motor Tube

Ürün Kodu / Product Code	5312
Kalınlık / Thickness	1,5 mm
Ağırlık / Weight	1,100 kg/m 2,425 lb/m

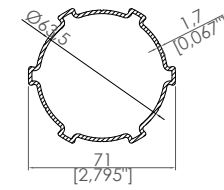

Motor Borusu Eki
Motor Tube Connection

Ürün Kodu / Product Code	37100
Kalınlık / Thickness	1,7 mm
Ağırlık / Weight	1,074 kg/m 2,368 lb/m

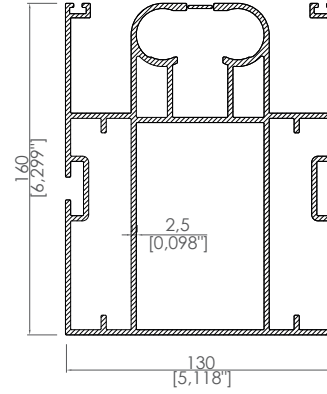

Ray Profili
Rail Profile

Ürün Kodu / Product Code	2339
Kalınlık / Thickness	2,5 mm
Ağırlık / Weight	7,827 kg/m 17,256 lb/m

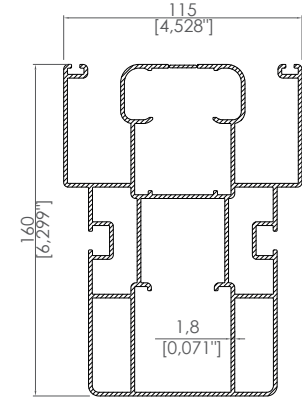

Eko Ray
Eco Rail Profile

Ürün Kodu / Product Code	2785
Kalınlık / Thickness	1,8 mm
Ağırlık / Weight	5,084 kg/m 11,208 lb/m

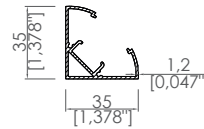

Led Profili
Led Profile

Ürün Kodu / Product Code	2953
Kalınlık / Thickness	1,2 mm
Ağırlık / Weight	0,445 kg/m 0,981 lb/m

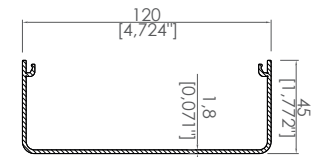

Dikme Kapak Profili
Pillar Cover Profile

Ürün Kodu / Product Code	2342
Kalınlık / Thickness	1,8 mm
Ağırlık / Weight	1,055 kg/m 2,326 lb/m

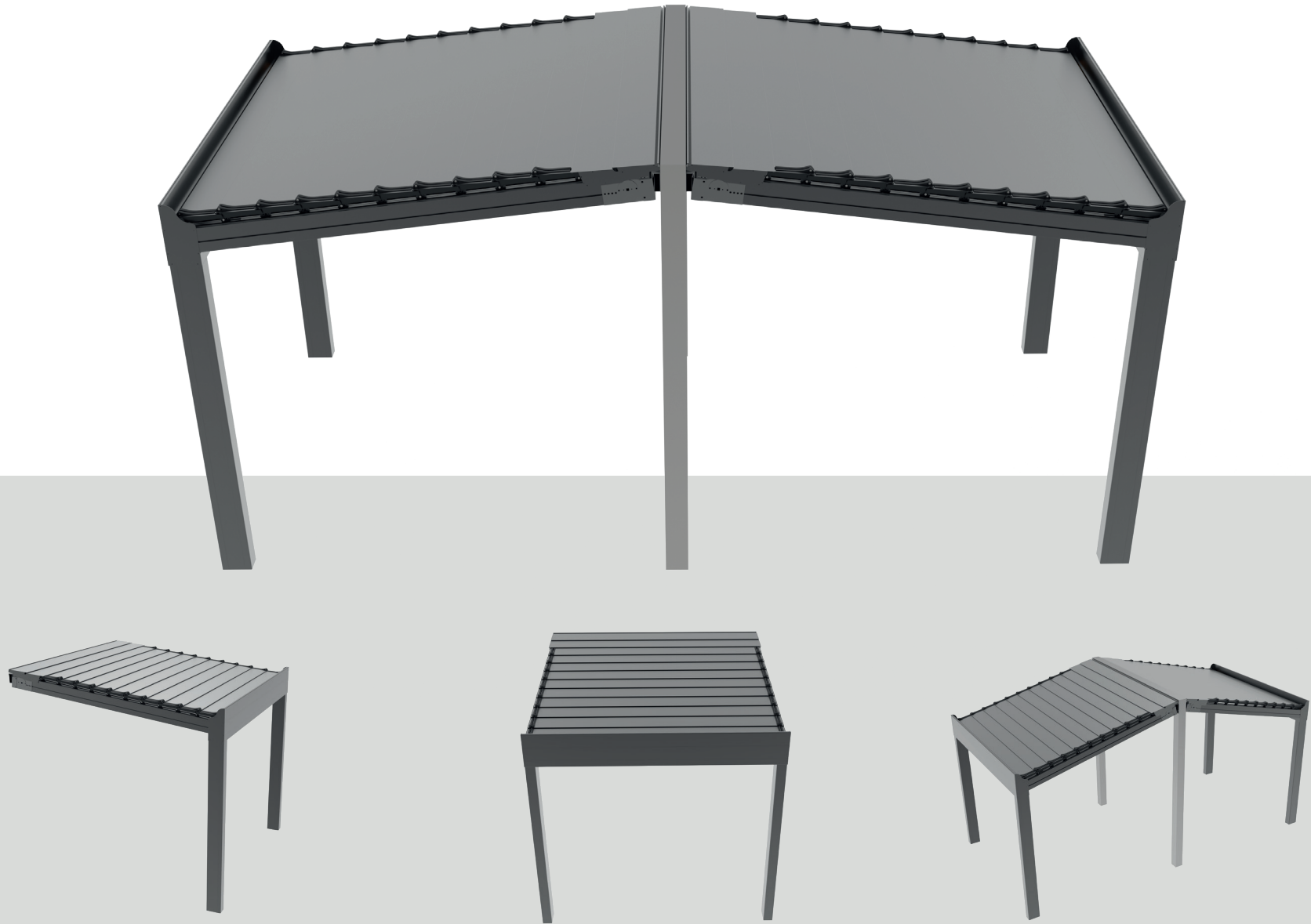

**HAREKETLİ VE SABİT
CAM SİSTEMLERİ**
MOVABLE AND FIXED GLASS
CEILING SYSTEMS

Veranda Sistemleri
Veranda Systems



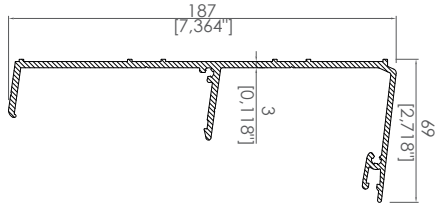

69x187 Arka Kayıt
69x187 Back Beam

Ürün Kodu / Product Code	2004
Kalınlık / Thickness	3 mm
Ağırlık / Weight	2,602 kg/m 5,736 lb/m

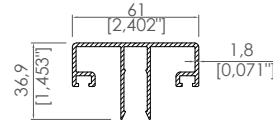

61x36,9 Orta Cam Kapak Profili
61x36,9 Middle Glass Cover Profile

Ürün Kodu / Product Code	2007
Kalınlık / Thickness	1,8 mm
Ağırlık / Weight	0,925 kg/m 2,0393 lb/m

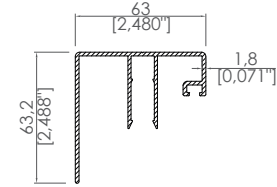

63x63,2 Kenar Cam Kapak Profili
63x63,2 Side Glass Cover Profile

Ürün Kodu / Product Code	2008
Kalınlık / Thickness	1,8 mm
Ağırlık / Weight	1,060 kg/m 2,337 lb/m

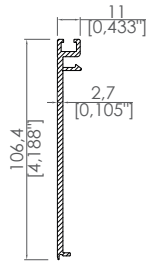

11x106,4 Dere ve Arka Kayıt Kapağı
11x106,4 Gutter and Back Beam Cover Profile

Ürün Kodu / Product Code	2011
Kalınlık / Thickness	2,7 mm
Ağırlık / Weight	0,890 kg/m 1,962 lb/m

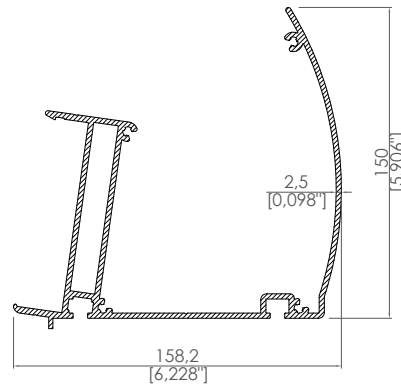

158,2x150 Oval Dere
158,2x150 Oval Gutter

Ürün Kodu / Product Code	2012
Kalınlık / Thickness	2,5 mm
Ağırlık / Weight	4,115 kg/m 9,072 lb/m

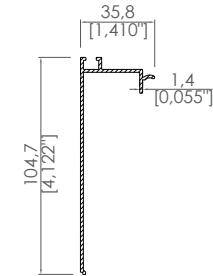

35,8x104,7 Dere ve Arka Kayıt Kapağı
35,8x104,7 Gutter and Back Beam Cover Profile

Ürün Kodu / Product Code	2533
Kalınlık / Thickness	1,4 mm
Ağırlık / Weight	0,600 kg/m 1,3228 lb/m

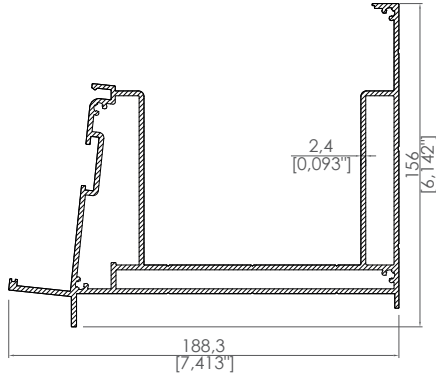

188,3x156 Düz Dere
188,3x156 Gutter Profile

Ürün Kodu / Product Code	2530
Kalınlık / Thickness	2,4 mm
Ağırlık / Weight	5,399 kg/m 11,903 lb/m

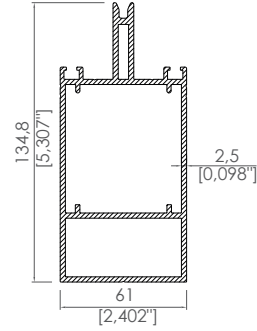

61x134,8 Cam Taşıyıcı
61x134,8 Glass Carrier Profile

Ürün Kodu / Product Code	2005
Kalınlık / Thickness	2,5 mm
Ağırlık / Weight	3,230 kg/m 7,121 lb/m

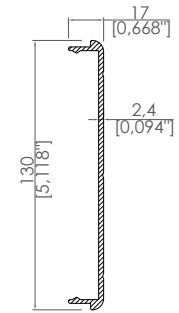

17x130 Dikme Kapak Profili
17x130 Pillar Cover Profile

Ürün Kodu / Product Code	2010
Kalınlık / Thickness	2,4 mm
Ağırlık / Weight	1,025 kg/m 2,2597 lb/m

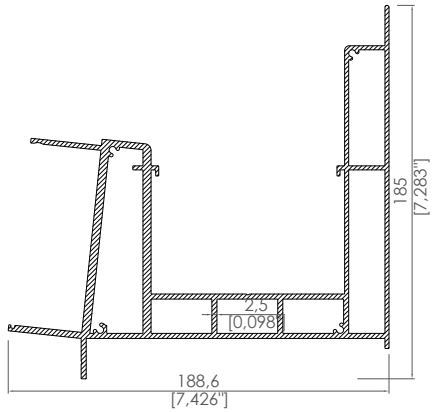

188x185 Düz Dere
188x185 Gutter Profiler

Ürün Kodu / Product Code	3535
Kalınlık / Thickness	2,5 mm
Ağırlık / Weight	6,827 kg/m 15,05 lb/m

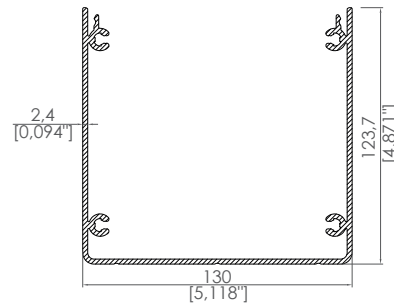

120x123 Dikme Gövde
120x123 Pillar Main

Ürün Kodu / Product Code	2009
Kalınlık / Thickness	2,4 mm
Ağırlık / Weight	3,057 kg/m 6,74 lb/m

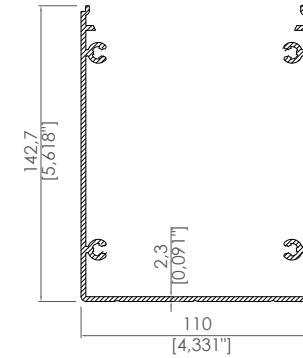

110x142,7 Dikme Gövde
110x142,7 Pillar Main

Ürün Kodu / Product Code	2301
Kalınlık / Thickness	2,3 mm
Ağırlık / Weight	3,003 kg/m 6,62 lb/m

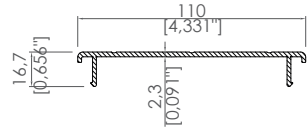

110x145 Dikme Kapak Profili
110x145 Pillar Cover Profile

Ürün Kodu / Product Code	2302
Kalınlık / Thickness	2,3 mm
Ağırlık / Weight	0,846 kg/m 1,865 lb/m

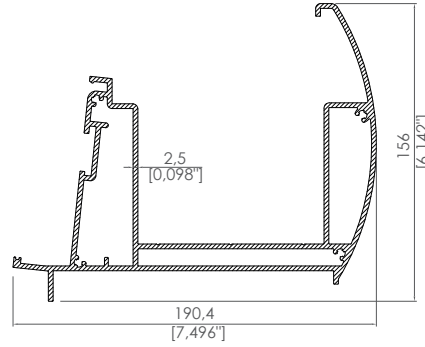

190,4X156 Oval Dere Profili
190,4X156 Oval Gutter

Ürün Kodu / Product Code	2594
Kalınlık / Thickness	2,5 mm
Ağırlık / Weight	5,619 kg/m 12,388 lb/m

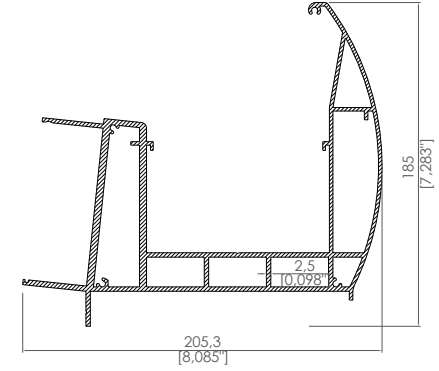

205,3X185 Oval Dere Profili
205,3X185 Oval Gutter Profile

Ürün Kodu / Product Code	3536
Kalınlık / Thickness	2,5 mm
Ağırlık / Weight	7,095 kg/m 15,642 lb/m

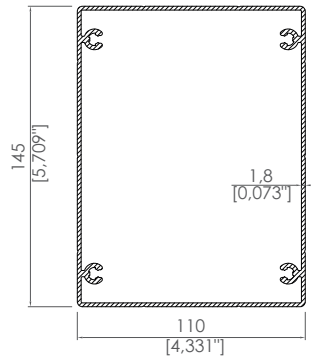

110x145 Dikme Profili
110x145 Pillar Profile

Ürün Kodu / Product Code	2111
Kalınlık / Thickness	1,8 mm
Ağırlık / Weight	3,044 kg/m 6,711 lb/m

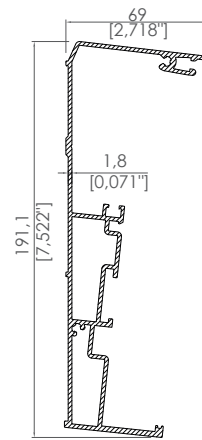

69x191 Arka Kayıt
69x191 Back Beam

Ürün Kodu / Product Code	2532
Kalınlık / Thickness	1,8 mm
Ağırlık / Weight	2,651 kg/m 5,844 lb/m

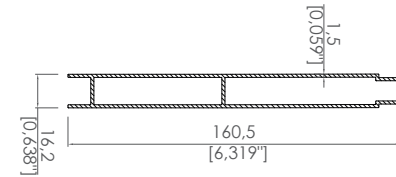

15x160 Panel Profili
15x160 Panel Profile

Ürün Kodu / Product Code	2546
Kalınlık / Thickness	1,5 mm
Ağırlık / Weight	1,465 kg/m 3,23 lb/m

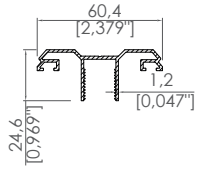

60,4x24,6 Cam Kapak Profili
60,4x24,6 Glass Cover Profile

Ürün Kodu / Product Code	2534
Kalınlık / Thickness	1,2 mm
Ağırlık / Weight	0,515 kg/m 1,1354 lb/m

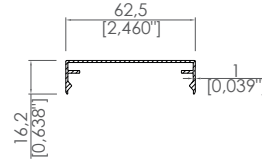

62,5x16,2 Orta Kapak Profili
62,5x16,2 Middle Profile Cover

Ürün Kodu / Product Code	2535
Kalınlık / Thickness	1 mm
Ağırlık / Weight	0,312 kg/m 0,6878 lb/m

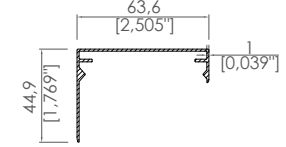

63,6x44,9 Kenar Kapak Profili
63,6x44,9 Side Profile Cover

Ürün Kodu / Product Code	2536
Kalınlık / Thickness	1 mm
Ağırlık / Weight	0,415 kg/m 0,915 lb/m

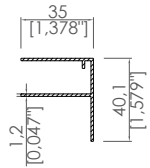

F Profil
F Profile

Ürün Kodu / Product Code	2643
Kalınlık / Thickness	1,2 mm
Ağırlık / Weight	0,365 kg/m 0,8047 lb/m

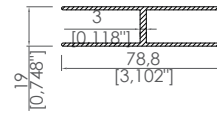

H Profil
H Profile

Ürün Kodu / Product Code	2642
Kalınlık / Thickness	3 mm
Ağırlık / Weight	0,770 kg/m 1,6976 lb/m

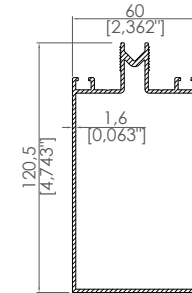

Standart Cam Taşıyıcı
Standart Glass Carrier Profile

Ürün Kodu / Product Code	2490
Kalınlık / Thickness	1,6 mm
Ağırlık / Weight	1,721 kg/m 3,794 lb/m

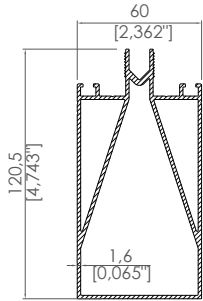

Destekli Cam Taşıyıcı 1
Supported Glass Carrier Profile 1

Ürün Kodu / Product Code	2935
Kalınlık / Thickness	1,6 mm
Ağırlık / Weight	2,440 kg/m 5,379 lb/m

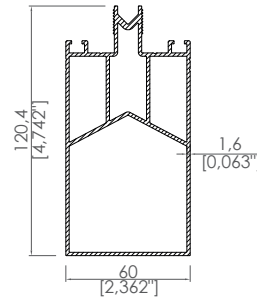

Destekli Cam Taşıyıcı 2
Supported Glass Carrier Profile 2

Ürün Kodu / Product Code	2490
Kalınlık / Thickness	1,6 mm
Ağırlık / Weight	2,274 kg/m 5,013 lb/m

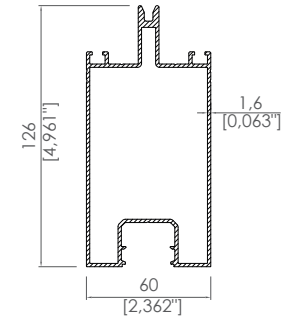

Şerit Ledli Cam Taşıyıcı Profili
Glass Carrier Profile Linear Led

Ürün Kodu / Product Code	2717
Kalınlık / Thickness	1,6 mm
Ağırlık / Weight	1,968 kg/m 4,339 lb/m

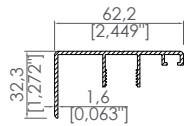

62,2x32,3 Kenar Cam Kapak Profili
62,2x32,3 Side Glass Cover Profile

Ürün Kodu / Product Code	2491
Kalınlık / Thickness	1,6 mm
Ağırlık / Weight	0,559 kg/m 1,2324 lb/m

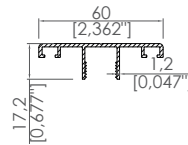

60x17,2 Cam Kapak Profili
60x17,2 Glass Cover Profile

Ürün Kodu / Product Code	2492
Kalınlık / Thickness	1,2 mm
Ağırlık / Weight	0,464 kg/m 1,023 lb/m

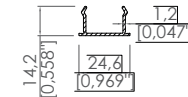

Cam Taşıyıcı Kapağı
Glass Carrier Cover

Ürün Kodu / Product Code	2716
Kalınlık / Thickness	1,2 mm
Ağırlık / Weight	0,166 kg/m 0,366 lb/m

**HAREKETLİ VE SABİT
CAM SİSTEMLERİ**
MOVABLE AND FIXED GLASS
CEILING SYSTEMS

Sürgülü Cam Çatı Sistemleri
Sliding Glass Roof Systems



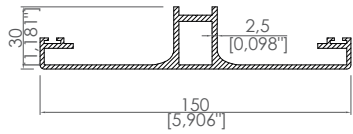

Alt Ray Profili
Bottom Rail Profile

Ürün Kodu / Product Code	2924
Kalınlık / Thickness	2,5 mm
Ağırlık / Weight	1,776 kg/m 3,9154 lb/m

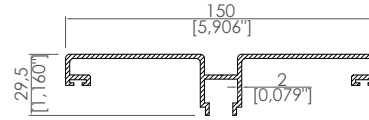

Üst Ray Profili
Top Rail Profile

Ürün Kodu / Product Code	2923
Kalınlık / Thickness	2 mm
Ağırlık / Weight	1,453 kg/m 3,203 lb/m

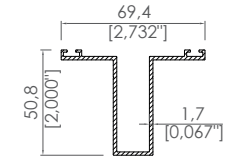

Panel Kavrama Profili
Panel Holder Profile

Ürün Kodu / Product Code	2925
Kalınlık / Thickness	1,7 mm
Ağırlık / Weight	0,795 kg/m 1,7527 lb/m

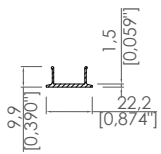

Ayarlanabilir Ray Profil Kapağı
Rail Adjusting Profile Cover

Ürün Kodu / Product Code	2926
Kalınlık / Thickness	1,5 mm
Ağırlık / Weight	0,120 kg/m 0,26455 lb/m

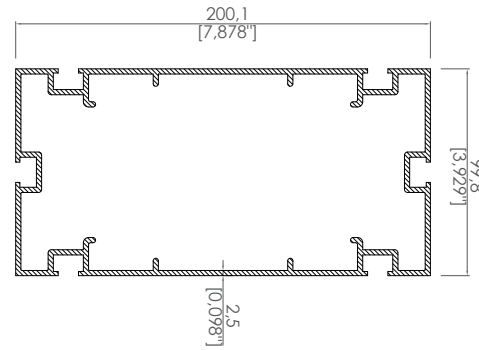

Arka Kayıt
Back Beam

Ürün Kodu / Product Code	2930
Kalınlık / Thickness	2,5 mm
Ağırlık / Weight	4,945 kg/m 10,902 lb/m

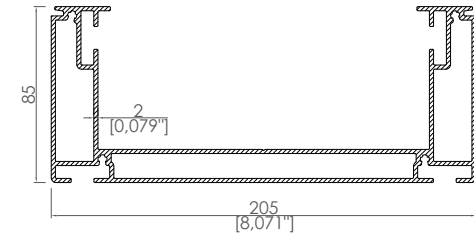

Dere Profili
Gutter Profile

Ürün Kodu / Product Code	2337
Kalınlık / Thickness	2 mm
Ağırlık / Weight	4,560 kg/m 10,053 lb/m

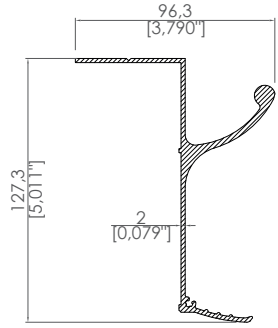

Arka Kayıt Bağlantı Ray Profili
Rail - Back Beam Connection Profile

Ürün Kodu / Product Code	2929
Kalınlık / Thickness	2 mm
Ağırlık / Weight	1,925 kg/m 4,244 lb/m

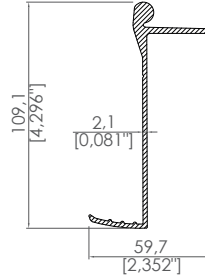

Dere Bağlantı Ray Profili
Rail - Gutter Connection Profile

Ürün Kodu / Product Code	2928
Kalınlık / Thickness	2,1 mm
Ağırlık / Weight	1,456 kg/m 3,21 lb/m

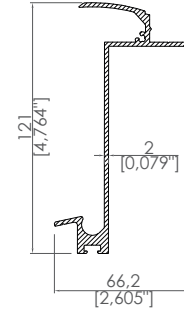

Ayarlanabilir Ray Profili
Rail Adjusting Profile

Ürün Kodu / Product Code	2927
Kalınlık / Thickness	2 mm
Ağırlık / Weight	1,529 kg/m 3,371 lb/m

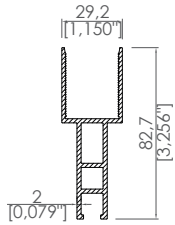

Cam Panel Kasa Profili
Glass Panel Side Profile

Ürün Kodu / Product Code	2502
Kalınlık / Thickness	2 mm
Ağırlık / Weight	1,125 kg/m 2,48 lb/m

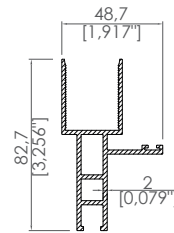

Panel Çekici Profili
Panel Puller Profile

Ürün Kodu / Product Code	2503
Kalınlık / Thickness	2 mm
Ağırlık / Weight	1,300 kg/m 2,866 lb/m

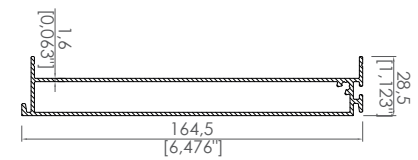

Dere Uzatma Profili
Gutter Extension Profile

Ürün Kodu / Product Code	2338
Kalınlık / Thickness	1,6mm
Ağırlık / Weight	1,730 kg/m 3,814 lb/m

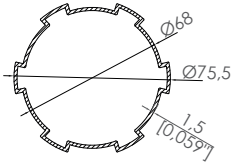

Motor Borusu
Motor Tube

Ürün Kodu / Product Code	5312
Kalınlık / Thickness	1,5 mm
Ağırlık / Weight	1,100 kg/m 2,425 lb/m

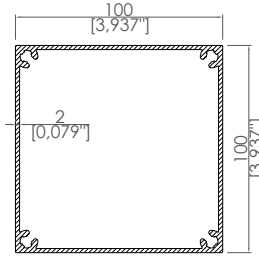

100x100 Dikme Profil
100X100 Pillar Profile

Ürün Kodu / Product Code	6565
Kalınlık / Thickness	2 mm
Ağırlık / Weight	2,463 kg/m 5,43 lb/m

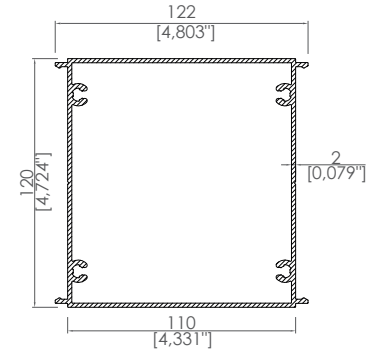

122x120 Dikme Gövde Profili
122x120 Pillar Main Profile

Ürün Kodu / Product Code	2341
Kalınlık / Thickness	2 mm
Ağırlık / Weight	3,028 kg/m 6,676 lb/m

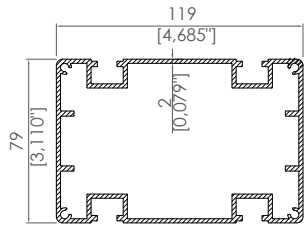

Taşıyıcı Profil
Carrier Profile

Ürün Kodu / Product Code	5936
Kalınlık / Thickness	2 mm
Ağırlık / Weight	3,032 kg/m 6,684 lb/m

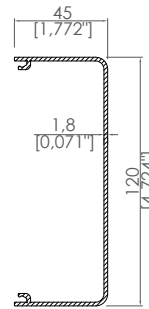

Dikme Kapak Profili
Pillar Cover Profile

Ürün Kodu / Product Code	2342
Kalınlık / Thickness	1,8 mm
Ağırlık / Weight	1,055 kg/m 2,326 lb/m

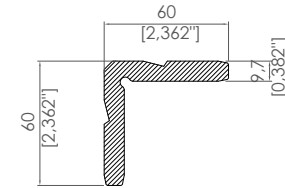

Köşe Takoz Profili
Corner Block Profile

Ürün Kodu / Product Code	3096
Kalınlık / Thickness	9,7 mm
Ağırlık / Weight	2,734 kg/m 6,027 lb/m

**HAREKETLİ VE SABİT
CAM SİSTEMLERİ**
MOVABLE AND FIXED GLASS
CEILING SYSTEMS

Küp Veranda Sistemleri
Cube Veranda Systems



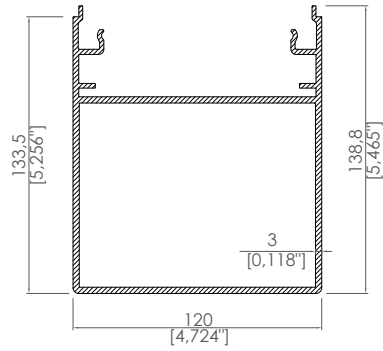

Yan Kayıt Profili
Side Beam Profile

Ürün Kodu / Product Code	3609
Kalınlık / Thickness	3 mm
Ağırlık / Weight	4,382 kg/m 9,66 lb/m

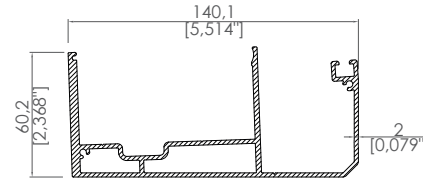

Arka Kayıt Profili
Back Beam Profile

Ürün Kodu / Product Code	3617
Kalınlık / Thickness	2 mm
Ağırlık / Weight	2,745 kg/m 6,052 lb/m

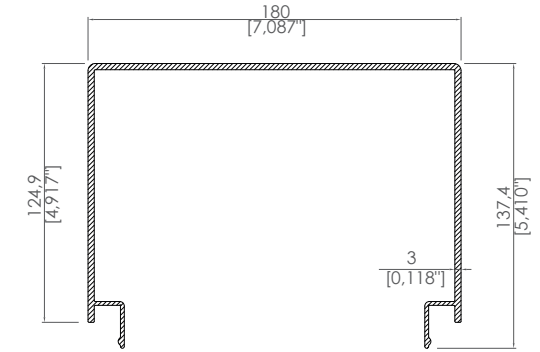

Dikme Kapak Profili
Pillar Cover Profile

Ürün Kodu / Product Code	3612
Kalınlık / Thickness	3 mm
Ağırlık / Weight	3,791 kg/m 8,358 lb/m

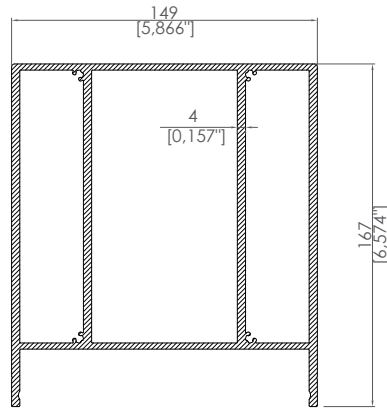

Orta Destek Profili
Middle Support Profile

Ürün Kodu / Product Code	3052
Kalınlık / Thickness	4 mm
Ağırlık / Weight	8,881 kg/m 19,58 lb/m

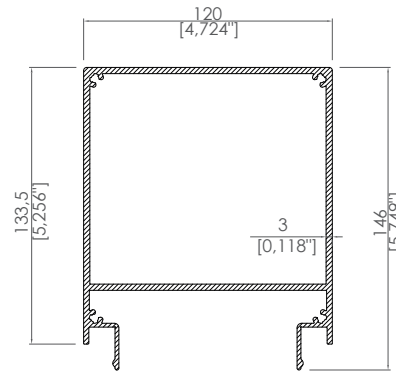

Yan Kayıt Üst Profili
Side Beam Top Profile

Ürün Kodu / Product Code	3610
Kalınlık / Thickness	3 mm
Ağırlık / Weight	4,501 kg/m 9,923 lb/m

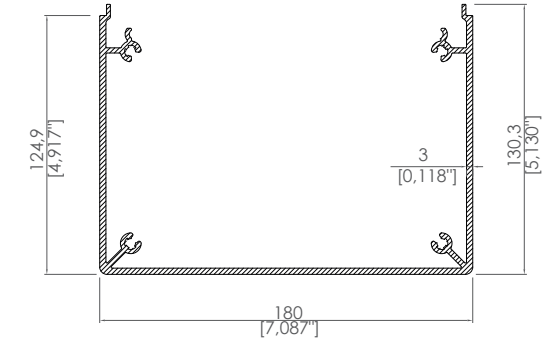

Dikme Gövde Profili
Pillar Main Profile

Ürün Kodu / Product Code	3611
Kalınlık / Thickness	3 mm
Ağırlık / Weight	4,314 kg/m 9,51 lb/m

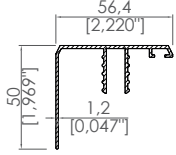

Kenar Cam Kapak Profili
Glass Cover Side Profile

Ürün Kodu / Product Code	3615
Kalınlık / Thickness	1,2 mm
Ağırlık / Weight	0,594 kg/m 1,3095 lb/m

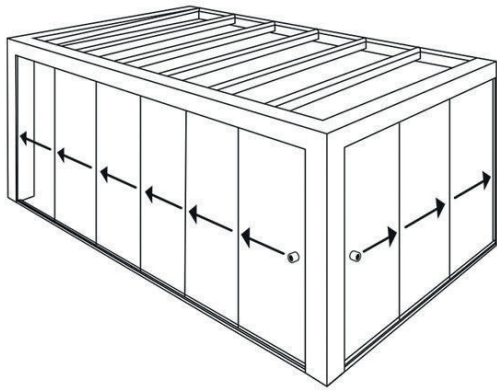

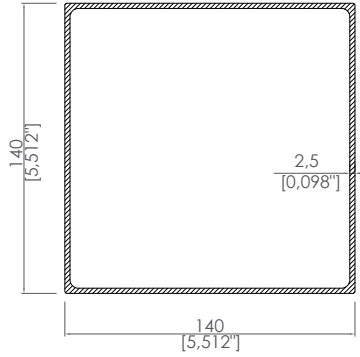

140x140 Dikme Profili
140x140 Pillar Profile

Ürün Kodu / Product Code	3054
Kalınlık / Thickness	2,5 mm
Ağırlık / Weight	3,780 kg/m 8,333 lb/m

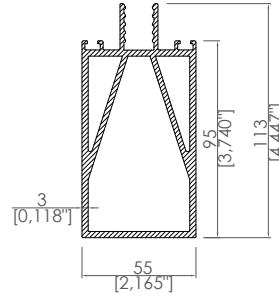

Cam Taşıyıcı Profil
Glass Carrier Profile

Ürün Kodu / Product Code	3613
Kalınlık / Thickness	3 mm
Ağırlık / Weight	3,431 kg/m 7,564 lb/m

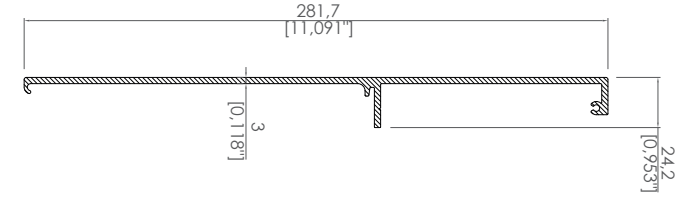

Dere Kapak Profili
Gutter Cover Profile

Ürün Kodu / Product Code	3607
Kalınlık / Thickness	3 mm
Ağırlık / Weight	2,713 kg/m 5,981 lb/m

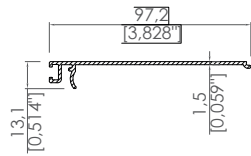

Dere ve Arka Kayıt Kapağı
Gutter and Back Beam Cover Profile

Ürün Kodu / Product Code	3616
Kalınlık / Thickness	1,5 mm
Ağırlık / Weight	0,507 kg/m 1,117 lb/m

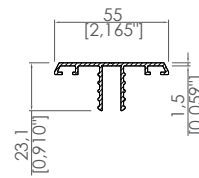

Orta Cam Kapak Profili
Middle Glass Cover Profile

Ürün Kodu / Product Code	3614
Kalınlık / Thickness	1,5 mm
Ağırlık / Weight	0,469 kg/m 1,034 lb/m

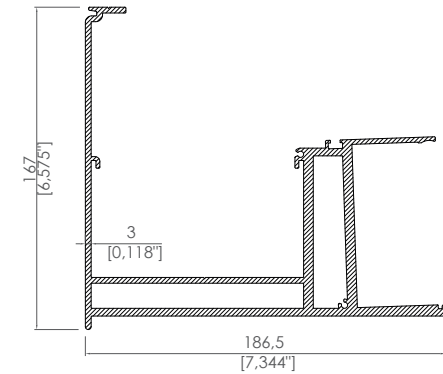

Dere Profili
Gutter Profile

Ürün Kodu / Product Code	3608
Kalınlık / Thickness	3 mm
Ağırlık / Weight	7,425 kg/m 16,37 lb/m

CAM SİSTEMLERİ
GLASS SYSTEMS

Modena Sürme Sistemleri
Modena Sliding Systems



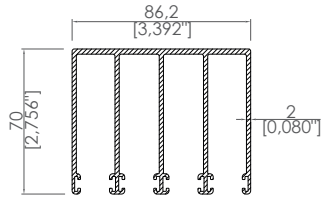

Dörtlü Üst Ray Profili
Four Rail Top Profile

Ürün Kodu / Product Code	2958
Kalınlık / Thickness	2 mm
Ağırlık / Weight	2,585 kg/m 5,699 lb/m

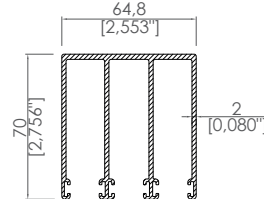

Üçlü Üst Ray Profili
Three Rail Top Profile

Ürün Kodu / Product Code	2957
Kalınlık / Thickness	2 mm
Ağırlık / Weight	2,025 kg/m 4,464 lb/m

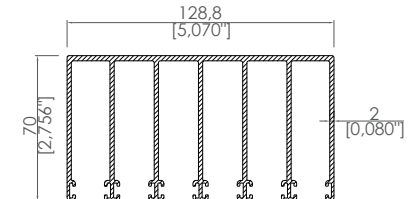

Altılı Üst Ray Profili
Six Rail Top Profile

Ürün Kodu / Product Code	2690
Kalınlık / Thickness	1,8 mm
Ağırlık / Weight	1,060 kg/m 2,337 lb/m

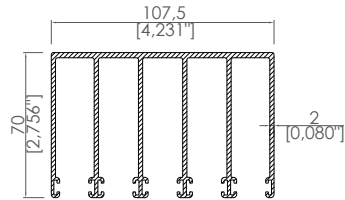

Beşli Üst Ray Profili
Five Rail Top Profile

Ürün Kodu / Product Code	2959
Kalınlık / Thickness	2 mm
Ağırlık / Weight	3,144 kg/m 6,931 lb/m

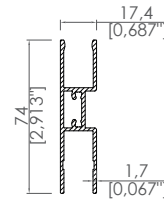

Sürme Panel Alt Profili
Sliding Glass Bottom Profile

Ürün Kodu / Product Code	2868
Kalınlık / Thickness	1,7 mm
Ağırlık / Weight	0,825 kg/m 1,818 lb/m

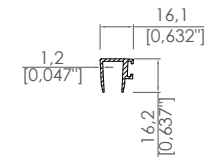

Cam Tutucu Profili
Glass Side Profile

Ürün Kodu / Product Code	3405
Kalınlık / Thickness	1,2 mm
Ağırlık / Weight	0,179 kg/m 0,3946 lb/m

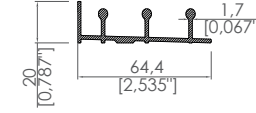
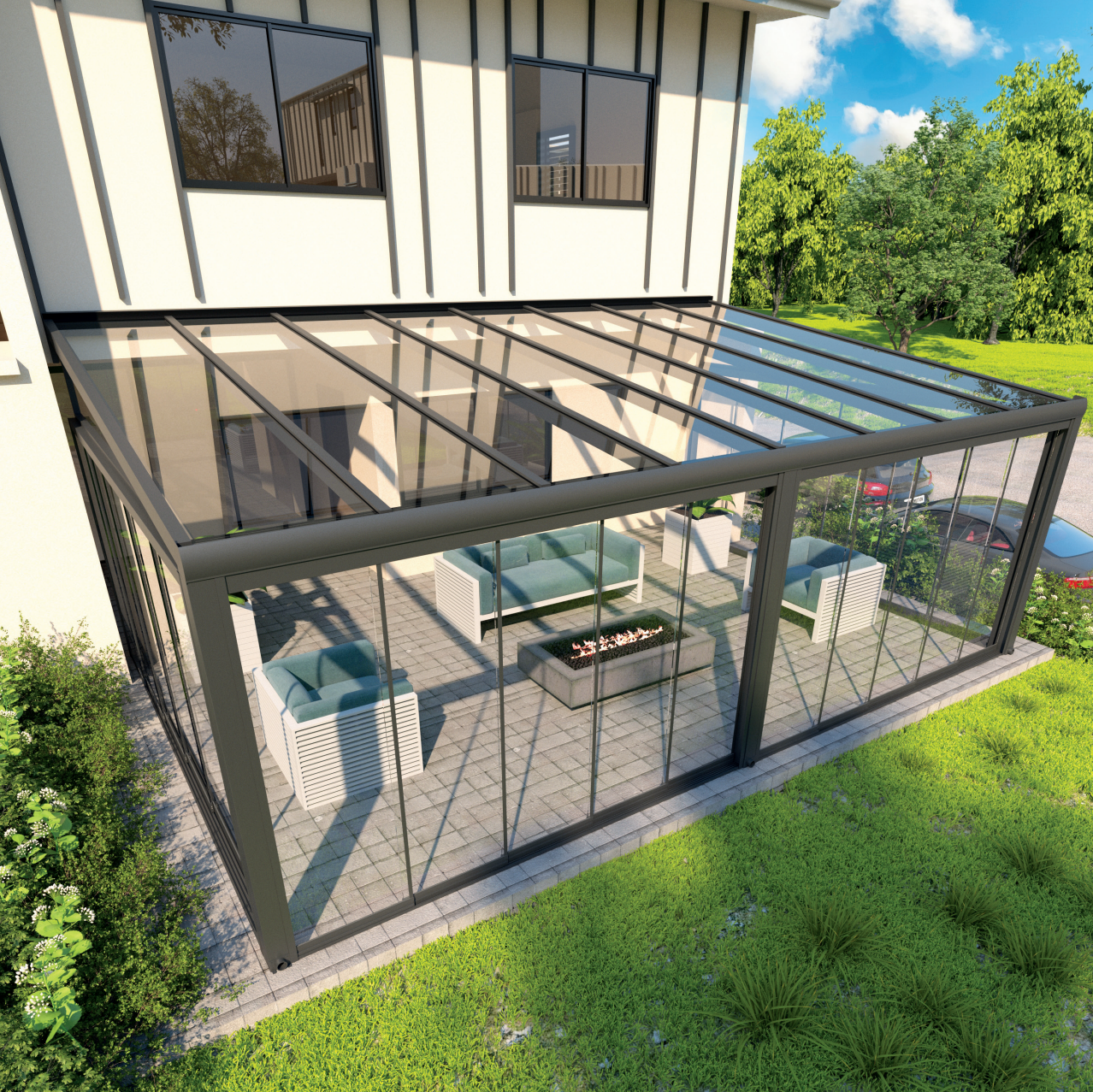

Üçlü Ray Alt Profili
Three Rail Bottom Profile

Ürün Kodu / Product Code	2869
Kalınlık / Thickness	1,7 mm
Ağırlık / Weight	0,696 kg/m 1,5344 lb/m

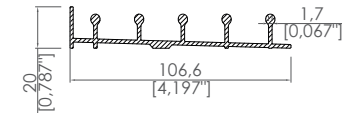

Beşli Ray Alt Profili
Five Rail Bottom Profile

Ürün Kodu / Product Code	2871
Kalınlık / Thickness	1,7 mm
Ağırlık / Weight	1,089 kg/m 2,401 lb/m

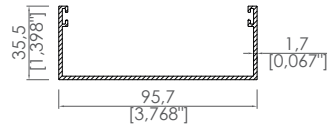

Dörtlü Yan Dikme Profili
Four Rail Side Profile

Ürün Kodu / Product Code	2962
Kalınlık / Thickness	1,7 mm
Ağırlık / Weight	0,810 kg/m 1,7857 lb/m

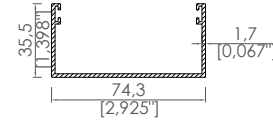

Üçlü Yan Dikme Profili
Three Rail Side Profile

Ürün Kodu / Product Code	2961
Kalınlık / Thickness	1,7 mm
Ağırlık / Weight	0,710 kg/m 1,5653 lb/m

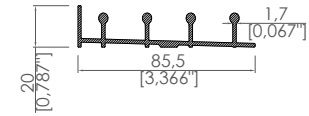

Dörtlü Ray Alt Profili
Four Rail Bottom Profile

Ürün Kodu / Product Code	2870
Kalınlık / Thickness	1,7 mm
Ağırlık / Weight	0,894 kg/m 1,971 lb/m

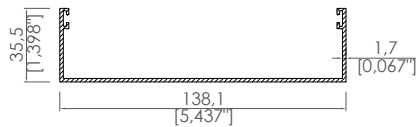

Altılı Yan Dikme Profili
Six Rail Side Profile

Ürün Kodu / Product Code	2964
Kalınlık / Thickness	1,7 mm
Ağırlık / Weight	1,010 kg/m 2,2267 lb/m

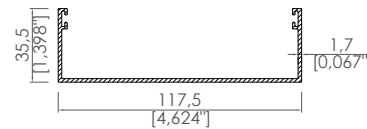

Beşli Yan Dikme Profili
Five Rail Side Profile

Ürün Kodu / Product Code	2963
Kalınlık / Thickness	1,7 mm
Ağırlık / Weight	0,910 kg/m 2,0062 lb/m

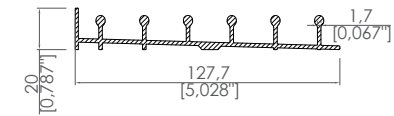

Altılı Ray Alt Profili
Six Rail Bottom Profile

Ürün Kodu / Product Code	2872
Kalınlık / Thickness	1,7 mm
Ağırlık / Weight	1,287 kg/m 2,8373 lb/m

CAM SİSTEMLERİ
GLASS SYSTEMS

Giyotin Cam Sistemleri
Guillotine Glass Systems



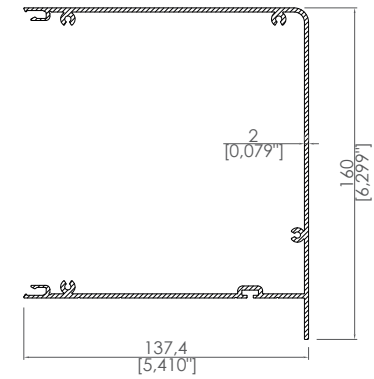
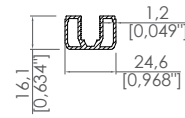
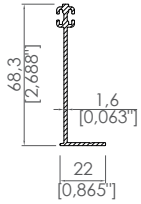

Ray Orta Profili
Rail Middle Profile

Ürün Kodu / Product Code	37268
Kalınlık / Thickness	1,6 mm
Ağırlık / Weight	0,464 kg/m 1,023 lb/m

8 mm Cam Adaptörü
8 mm Glass Adapter

Ürün Kodu / Product Code	37281
Kalınlık / Thickness	1,2 mm
Ağırlık / Weight	0,353 kg/m 0,7782 lb/m

Motor Kutusu Profili
Motor Box Profile

Ürün Kodu / Product Code	37272
Kalınlık / Thickness	2 mm
Ağırlık / Weight	2,700 kg/m 5,952 lb/m

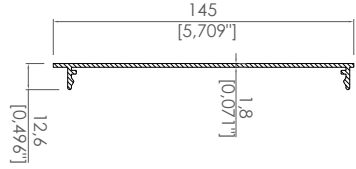

Motor Kutusu Kapak Profili
Motor Box Cover Profile

Ürün Kodu / Product Code	37271
Kalınlık / Thickness	1,8 mm
Ağırlık / Weight	0,847 kg/m 1,8673 lb/m

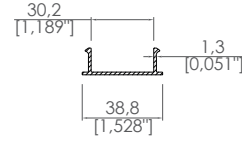

Ray Kapak Profili
Rail Cover Profile

Ürün Kodu / Product Code	37270
Kalınlık / Thickness	1,3 mm
Ağırlık / Weight	0,230 kg/m 0,5071 lb/m

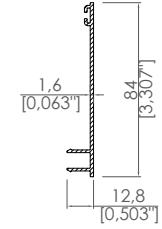

Yan Ray Kapak Profili
Side Rail Cover Profile

Ürün Kodu / Product Code	37269
Kalınlık / Thickness	1,6 mm
Ağırlık / Weight	0,475 kg/m 1,0472 lb/m

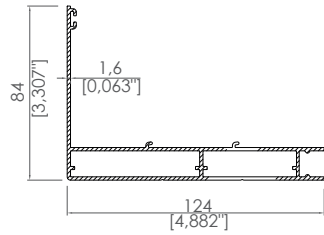

Yan Ray Profili
Side Rail Profile

Ürün Kodu / Product Code	37267
Kalınlık / Thickness	1,6 mm
Ağırlık / Weight	0,559 kg/m 1,2324 lb/m

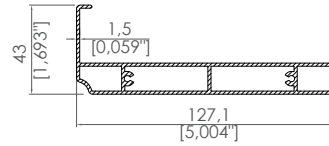

Alt Baza Profili
Sill Profile

Ürün Kodu / Product Code	37266
Kalınlık / Thickness	1,2 mm
Ağırlık / Weight	0,464 kg/m 1,023 lb/m

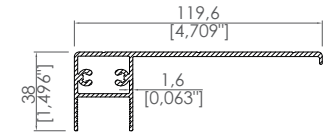

24mm Cam Trabzan Profili
24mm Glass Handrail Profile

Ürün Kodu / Product Code	37265
Kalınlık / Thickness	1,6 mm
Ağırlık / Weight	1,285 kg/m 2,833 lb/m

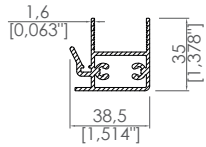

24mm Cam Çekici Profili
24mm Glass Puller Profile

Ürün Kodu / Product Code	37264
Kalınlık / Thickness	1,6 mm
Ağırlık / Weight	0,825 kg/m 1,8188 lb/m

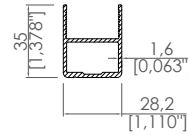

24mm Cam Çerçeve Profili
24mm Glass Frame Profile

Ürün Kodu / Product Code	37263
Kalınlık / Thickness	1,6 mm
Ağırlık / Weight	0,545 kg/m 1,2015 lb/m

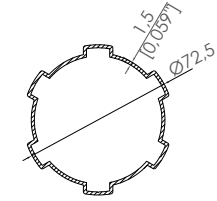

Motor Tüp Borusu
Motor Tube Profile

Ürün Kodu / Product Code	37115
Kalınlık / Thickness	1,5 mm
Ağırlık / Weight	0,992 kg/m 2,187 lb/m

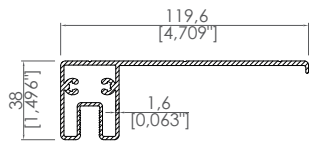

8mm Cam Trabzan Profili
8mm Glass Handrail Profile

Ürün Kodu / Product Code	37275
Kalınlık / Thickness	1,6 mm
Ağırlık / Weight	1,406 kg/m 3,1 lb/m

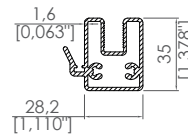

8mm Cam Panel Çekici Profili
8mm Glass Panel Puller Profile

Ürün Kodu / Product Code	37274
Kalınlık / Thickness	1,6 mm
Ağırlık / Weight	0,909 kg/m 2,004 lb/m

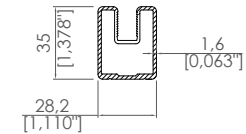

8 mm Cam Çerçeve Profili
8 mm Glass Frame Profile

Ürün Kodu / Product Code	37273
Kalınlık / Thickness	1,6 mm
Ağırlık / Weight	0,664 kg/m 1,464 lb/m

CAM SİSTEMLERİ
GLASS SYSTEMS

Isı Camlı Sürme Sistemleri
Double Glass Sliding Systems



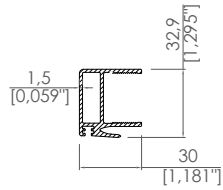

62,2x32,3 Kenar Cam Kapak Profili
62,2x32,3 Side Glass Cover Profile

Ürün Kodu / Product Code	2065
Kalınlık / Thickness	1,5 mm
Ağırlık / Weight	0,585 kg/m 1,2897 lb/m

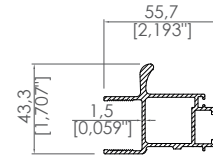

60x17,2 Cam Kapak Profili
60x17,2 Glass Cover Profile

Ürün Kodu / Product Code	2068
Kalınlık / Thickness	1,5 mm
Ağırlık / Weight	0,878 kg/m 1,9357 lb/m

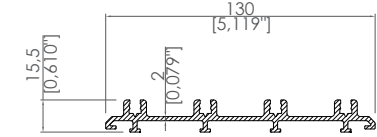

Cam Taşıyıcı Kapağı
Glass Carrier Cover

Ürün Kodu / Product Code	2070
Kalınlık / Thickness	2 mm
Ağırlık / Weight	1,480 kg/m 3,263 lb/m

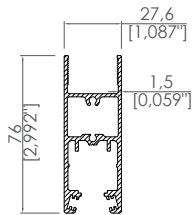

22mm Cam Panel Alt Profili
22mm Glass Panel Bottom Profile

Ürün Kodu / Product Code	2565
Kalınlık / Thickness	1,5 mm
Ağırlık / Weight	1,205 kg/m 2,6566 lb/m

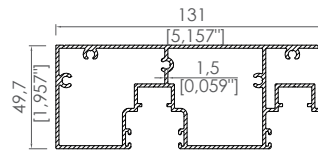

Yan Ray Profili
Side Rail Profile

Ürün Kodu / Product Code	2066
Kalınlık / Thickness	1,5 mm
Ağırlık / Weight	2,414 kg/m 5,322 lb/m

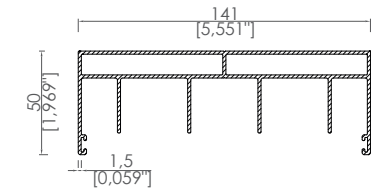

Üst Ray Profili
Top Rail Profile

Ürün Kodu / Product Code	2069
Kalınlık / Thickness	1,5 mm
Ağırlık / Weight	2,054 kg/m 4,528 lb/m

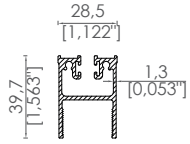

22 mm Cam Panel Üst Profili
22 mm Glass Panel Top Profile

Ürün Kodu / Product Code	2071
Kalınlık / Thickness	1,3 mm
Ağırlık / Weight	0,703 kg/m 1,55 lb/m

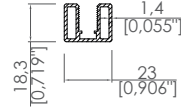

8 mm Cam Adaptör Profili
8 mm Glass Adapter Profile

Ürün Kodu / Product Code	2150
Kalınlık / Thickness	1,4 mm
Ağırlık / Weight	0,375 kg/m 0,8267 lb/m

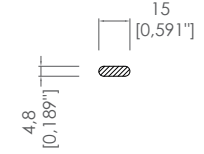

Alt Ray Teker Profili
Bottom Rail Wheel Profile

Ürün Kodu / Product Code	2117
Kalınlık / Thickness	4,8 mm
Ağırlık / Weight	0,185 kg/m 0,40786 lb/m

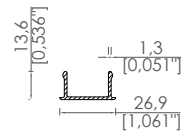

Yan Ray Profil Kapağı
Side Rail Cover Profile

Ürün Kodu / Product Code	2067
Kalınlık / Thickness	1,3 mm
Ağırlık / Weight	0,186 kg/m 0,4101 lb/m

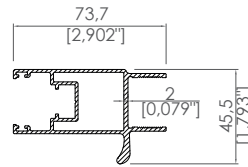

Orta Kanat Birleştirme Profili
Middle Panel Side Profile

Ürün Kodu / Product Code	2149
Kalınlık / Thickness	2 mm
Ağırlık / Weight	1,160 kg/m 2,5574 lb/m

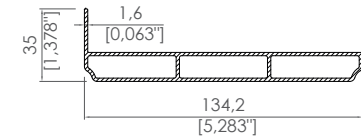

Baza Profili
Sill Profile

Ürün Kodu / Product Code	2566
Kalınlık / Thickness	1,6 mm
Ağırlık / Weight	1,423 kg/m 3,137 lb/m



CAM SİSTEMLERİ
GLASS SYSTEMS

Katlanır Cam Sistemleri
Folding Glass Systems



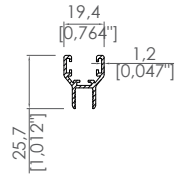

H - Profili
H - Profile

Ürün Kodu / Product Code	2164
Kalınlık / Thickness	1,2 mm
Ağırlık / Weight	0,297 kg/m 0,6548 lb/m

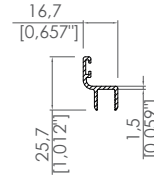

L- Profili
L - Profile

Ürün Kodu / Product Code	2165
Kalınlık / Thickness	1,5 mm
Ağırlık / Weight	0,210 kg/m 0,463 lb/m

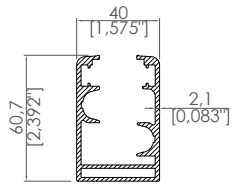

40x60,7 Ray Profili
40x60,7 Rail Profile

Ürün Kodu / Product Code	37074
Kalınlık / Thickness	2,1 mm
Ağırlık / Weight	1,469 kg/m 3,2386 lb/m

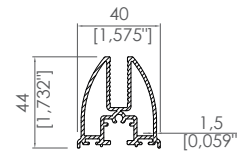

40x44 Panel Profili
40x44 Panel Profile

Ürün Kodu / Product Code	37073
Kalınlık / Thickness	1,5 mm
Ağırlık / Weight	0,992 kg/m 2,187 lb/m



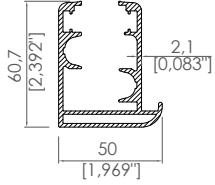

50x60,7 Ray Profili
50x60,7 Rail Profile

Ürün Kodu / Product Code	2162
Kalınlık / Thickness	2,1 mm
Ağırlık / Weight	1,555 kg/m 3,428 lb/m

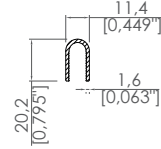

Kanat Dönüş Profili
Panel turning profile

Ürün Kodu / Product Code	2163
Kalınlık / Thickness	1,6 mm
Ağırlık / Weight	0,182 kg/m 0,40124 lb/m

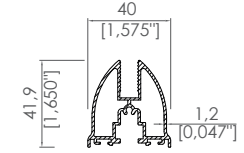

40x41,90 Panel Alt Ve Üst Profili
40x41,90 Panel Top and Bottom Profile

Ürün Kodu / Product Code	32025
Kalınlık / Thickness	1,2 mm
Ağırlık / Weight	0,775 kg/m 1,7086 lb/m

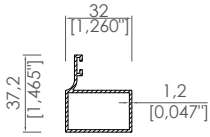

Geniş Yan Kasa Dikme Profili
Thick Side Pillar Box Profile

Ürün Kodu / Product Code	37075
Kalınlık / Thickness	1,2 mm
Ağırlık / Weight	0,412 kg/m 0,9083 lb/m

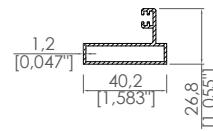

Dar Yan Kasa Dikme Profili
Thin Side Pillar Box Profile

Ürün Kodu / Product Code	32024
Kalınlık / Thickness	1,2 mm
Ağırlık / Weight	0,430 kg/m 0,948 lb/m

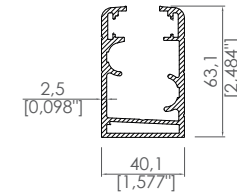

40x63 Ray Profili
40x63 Rail Profile

Ürün Kodu / Product Code	32023
Kalınlık / Thickness	2,5 mm
Ağırlık / Weight	1,632 kg/m 3,598 lb/m

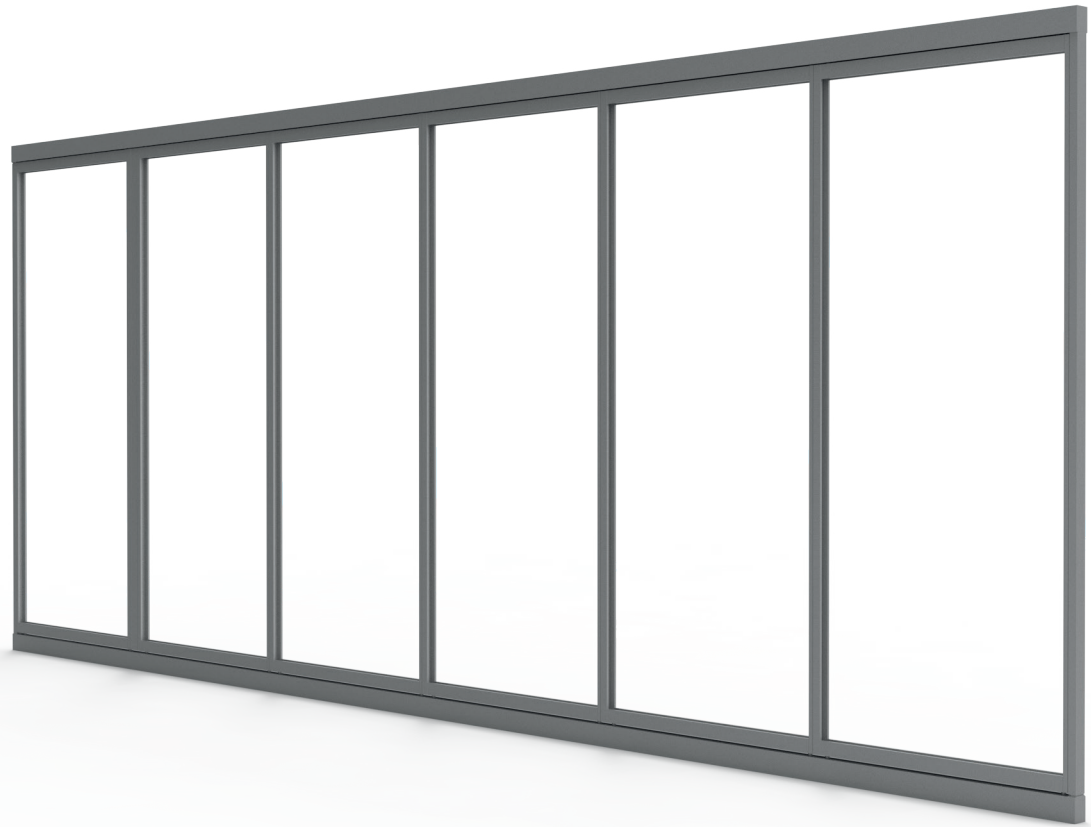
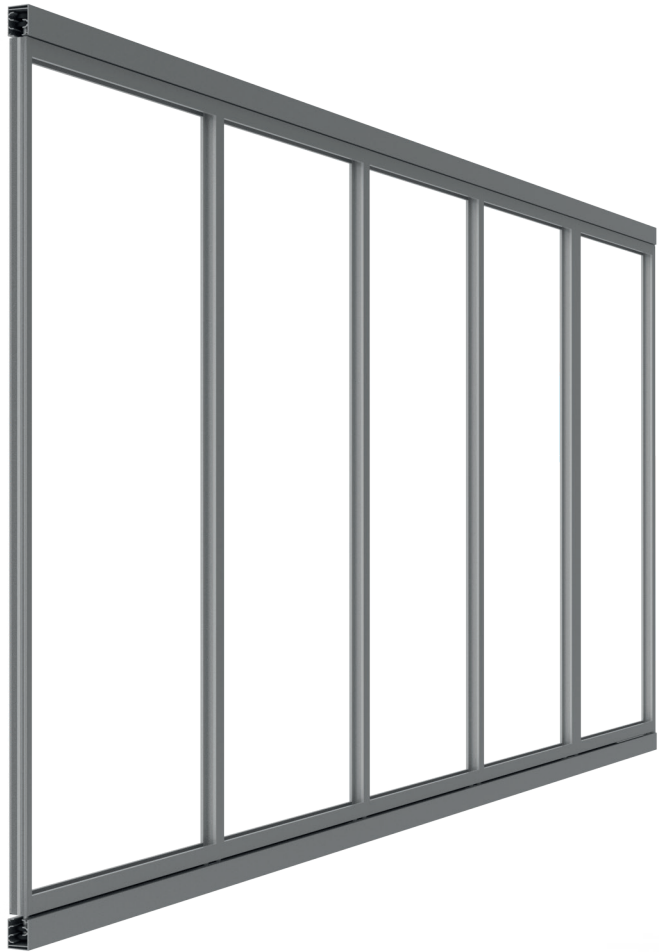

CAM SİSTEMLERİ
GLASS SYSTEMS

Tuba Çift Camlı Sürme Sistemleri
Tuba Double Glass Sliding Systems



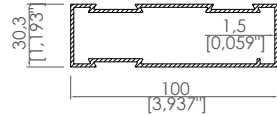

Kasa Profili
Frame Profile

Ürün Kodu / Product Code	2407
Kalınlık / Thickness	1,5 mm
Ağırlık / Weight	1,1152 kg/m 2,5397 lb/m

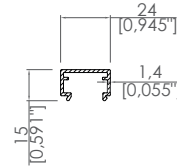

Üst Ray Profili
Top Rail Profile

Ürün Kodu / Product Code	2410
Kalınlık / Thickness	1,4 mm
Ağırlık / Weight	0,235 kg/m 0,5181 lb/m

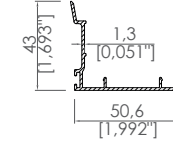

Çerçeve Kenet Profili
Frame Bead Profile

Ürün Kodu / Product Code	2409
Kalınlık / Thickness	1,3 mm
Ağırlık / Weight	0,391 kg/m 0,862 lb/m

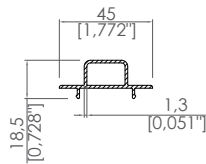

Kapak Profili
Cover Profile

Ürün Kodu / Product Code	2414
Kalınlık / Thickness	1,3 mm
Ağırlık / Weight	0,347 kg/m 0,765 lb/m

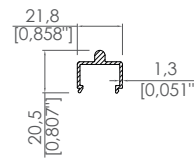

Alt Ray Teker Profili
Bottom Rail Wheel Profile

Ürün Kodu / Product Code	2411
Kalınlık / Thickness	1,3 mm
Ağırlık / Weight	0,280 kg/m 0,6173 lb/m

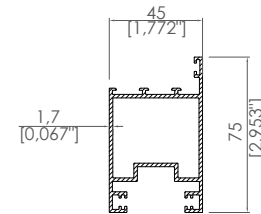

Cam Kanat Profili
Glass Panel Profile

Ürün Kodu / Product Code	2408
Kalınlık / Thickness	1,7 mm
Ağırlık / Weight	1,261 kg/m 2,78 lb/m

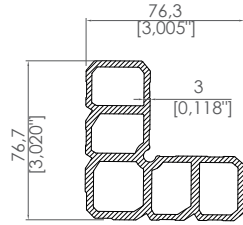

Cam Panel Köşe Takoğu
Glass Panel Corner Block Profile

Ürün Kodu / Product Code	2972
Kalınlık / Thickness	3 mm
Ağırlık / Weight	3,902 kg/m 8,602 lb/m

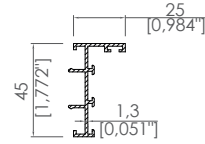

Sabit Panel Yan Çerçeve Profili
Fix Panel Side Frame Profile

Ürün Kodu / Product Code	2415
Kalınlık / Thickness	1,3 mm
Ağırlık / Weight	0,142 kg/m 0,31306 lb/m

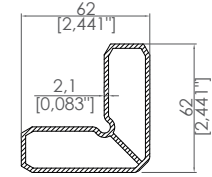

Çerçeve Köşe Takoğu Bağlantı Profili
Frame Corner Block Connection Profile

Ürün Kodu / Product Code	2971
Kalınlık / Thickness	2,1 mm
Ağırlık / Weight	3,650 kg/m 8,047 lb/m

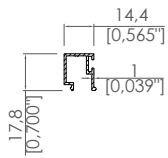

Dar Cam Çıtası
Thin Glazing Bead Profile

Ürün Kodu / Product Code	2412
Kalınlık / Thickness	1 mm
Ağırlık / Weight	0,166 kg/m 0,366 lb/m

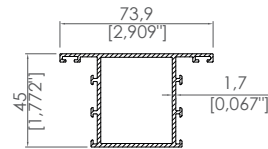

Orta Kayıt Profili
Glass Middle Profile

Ürün Kodu / Product Code	2973
Kalınlık / Thickness	1,7 mm
Ağırlık / Weight	1,038 kg/m 2,2884 lb/m

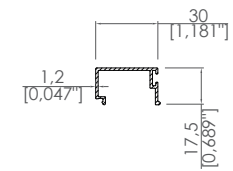

Geniş Cam Çıtası
Thick Glazing Bead Profile

Ürün Kodu / Product Code	2413
Kalınlık / Thickness	1,2 mm
Ağırlık / Weight	0,239 kg/m 0,5269 lb/m



CAM SİSTEMLERİ

GLASS SYSTEMS

Petra Çift Camlı Sürme Sistemleri
Petra Double Glass Sliding Systems



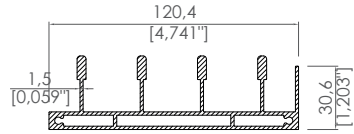

Dörtlü Üst Ray Profili
Four Rail Top Profile

Ürün Kodu / Product Code	2470
Kalınlık / Thickness	1,5 mm
Ağırlık / Weight	2,092 kg/m 4,612 lb/m

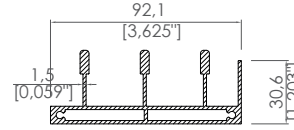

Üçlü Üst Ray Profili
Three Rail Top Profile

Ürün Kodu / Product Code	2469
Kalınlık / Thickness	1,5 mm
Ağırlık / Weight	1,631 kg/m 3,596 lb/m

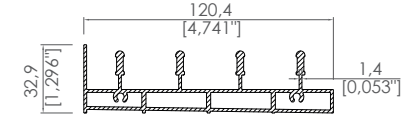

Dörtlü Alt Ray Profili
Four Rail Bottom Profile

Ürün Kodu / Product Code	2377
Kalınlık / Thickness	1,4 mm
Ağırlık / Weight	1,818 kg/m 4,008 lb/m

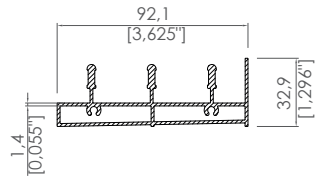

Üçlü Alt Ray Profili
Three Rail Bottom Profile

Ürün Kodu / Product Code	2355
Kalınlık / Thickness	1,4 mm
Ağırlık / Weight	1,369 kg/m 3,018 lb/m

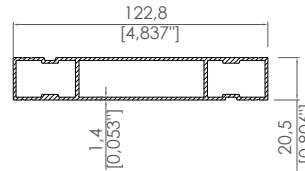

Dörtlü Yan Ray Profili
Four Rail Side Profile

Ürün Kodu / Product Code	2376
Kalınlık / Thickness	1,4 mm
Ağırlık / Weight	1,266 kg/m 2,791 lb/m

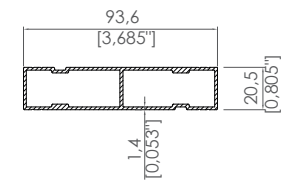

Üçlü Yan Ray Profili
Three Rail Side Profile

Ürün Kodu / Product Code	2357
Kalınlık / Thickness	1,4 mm
Ağırlık / Weight	0,962 kg/m 2,099 lb/m

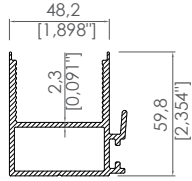

Cam Panel Yan Profili
Glass Panel Side Profile

Ürün Kodu / Product Code	2467
Kalınlık / Thickness	2,3 mm
Ağırlık / Weight	0,404 kg/m 0,8907 lb/m

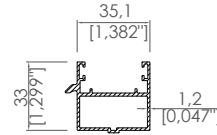

Son Panel Profili
Side Panel Profile

Ürün Kodu / Product Code	3268
Kalınlık / Thickness	1,2 mm
Ağırlık / Weight	0,554 kg/m 1,2214 lb/m

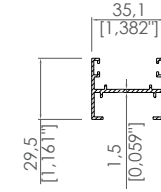

Orta Panel Birleştirme Profili
Middle Panel Connection Profile

Ürün Kodu / Product Code	3270
Kalınlık / Thickness	1,5 mm
Ağırlık / Weight	0,420 kg/m 0,926 lb/m

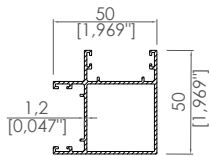

Köşe Panel Profili
Corner Panel Profile

Ürün Kodu / Product Code	3271
Kalınlık / Thickness	1,2 mm
Ağırlık / Weight	0,748 kg/m 1,649 lb/m

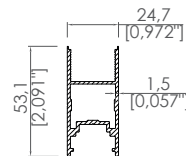

İspanyolet Profili
Glass Panel Handle Lock Profile

Ürün Kodu / Product Code	3568
Kalınlık / Thickness	1,5 mm
Ağırlık / Weight	0,675 kg/m 1,488 lb/m

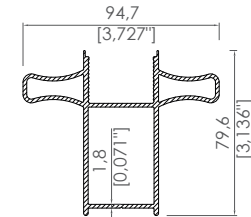

Kulplu Panel Profili
Glass Panel Handle Profile

Ürün Kodu / Product Code	3215
Kalınlık / Thickness	1,8 mm
Ağırlık / Weight	0,848 kg/m 1,8695 lb/m

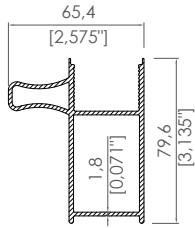

Tek Kulplu Panel Profil
Glass Panel Single Handle Profile

Ürün Kodu / Product Code	3216
Kalınlık / Thickness	1,8 mm
Ağırlık / Weight	0,702 kg/m 1,5476 lb/m

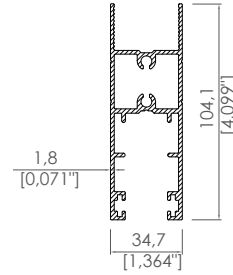

Cam Panel Alt ve Üst Profili
Glass Panel Top and Bottom Profile

Ürün Kodu / Product Code	2356
Kalınlık / Thickness	1,8 mm
Ağırlık / Weight	0,764 kg/m 1,6843 lb/m

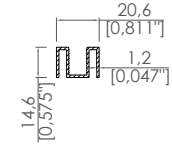

8 mm Cam Adaptörü
8 mm Glass Adapter

Ürün Kodu / Product Code	3269
Kalınlık / Thickness	1,2 mm
Ağırlık / Weight	0,233 kg/m 0,5137 lb/m



CAM SİSTEMLERİ
GLASS SYSTEMS

Lotus Giyotin Cam Sistemleri
Lotus Guillotine Glass Systems



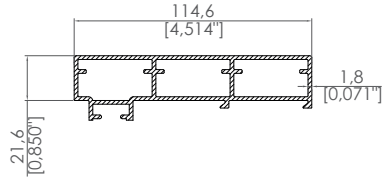

Yan Ray Profili
Side Rail Profile

Ürün Kodu / Product Code	3570
Kalınlık / Thickness	1,8 mm
Ağırlık / Weight	1,772 kg/m 3,9066 lb/m

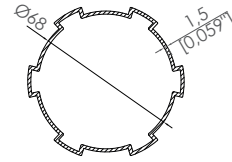

Motor Tüp Profili
Motor Tube Profile

Ürün Kodu / Product Code	5312
Kalınlık / Thickness	1,5 mm
Ağırlık / Weight	1,100 kg/m 2,425 lb/m

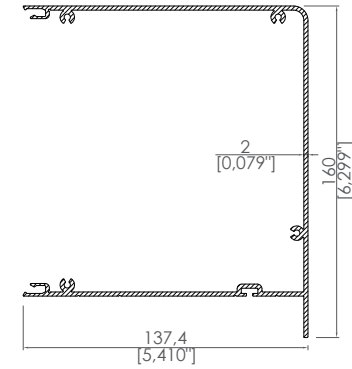

Motor Kutusu Profili
Motor Box Profile

Ürün Kodu / Product Code	37272
Kalınlık / Thickness	2 mm
Ağırlık / Weight	2,700 kg/m 5,952 lb/m

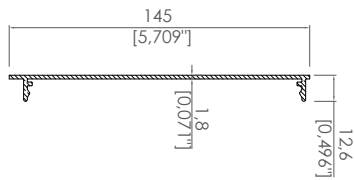

Motor Kutusu Kapak Profili
Motor Box Cover Profile

Ürün Kodu / Product Code	37271
Kalınlık / Thickness	1,8 mm
Ağırlık / Weight	0,847 kg/m 1,8673 lb/m

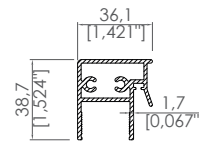

22mm Cam Panel Çekiçi Profili
22mm Glass Panel Puller Profile

Ürün Kodu / Product Code	3068
Kalınlık / Thickness	1,7 mm
Ağırlık / Weight	0,860 kg/m 1,896 lb/m

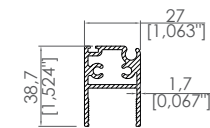

22mm Trabzan Profili
22mm Handrail Profile

Ürün Kodu / Product Code	3067
Kalınlık / Thickness	1,7 mm
Ağırlık / Weight	0,800 kg/m 1,7637 lb/m

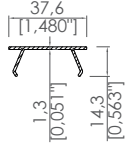

Ray Kapak Profili
Rail Cover Profile

Ürün Kodu / Product Code	3688
Kalınlık / Thickness	1,3 mm
Ağırlık / Weight	0,214 kg/m 0,4718 lb/m

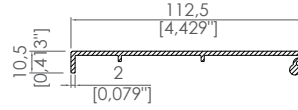

Trabzan Kapak Profili
Handrail Cover Profile

Ürün Kodu / Product Code	3070
Kalınlık / Thickness	2 mm
Ağırlık / Weight	0,770 kg/m 1,6976 lb/m

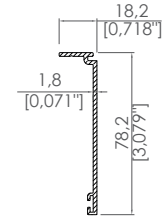

Yan Ray Kapak Profili
Side Rail Cover Profile

Ürün Kodu / Product Code	3071
Kalınlık / Thickness	1,8 mm
Ağırlık / Weight	0,510 kg/m 1,1244 lb/m

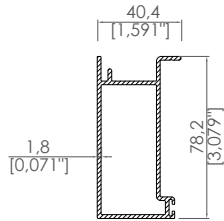

Yan Ray Dikme Profili
Side Rail Pillar Profile

Ürün Kodu / Product Code	3072
Kalınlık / Thickness	1,8 mm
Ağırlık / Weight	1,170 kg/m 2,5794 lb/m

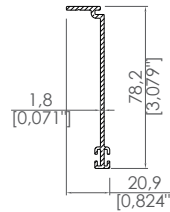

Yan Ray Orta Profil
Side Rail Middle Profile

Ürün Kodu / Product Code	3073
Kalınlık / Thickness	1,8 mm
Ağırlık / Weight	0,540 kg/m 1,1905 lb/m

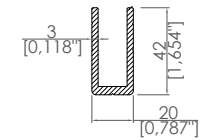

Zincir Askı Profili
Chain Hanger Profile

Ürün Kodu / Product Code	3244
Kalınlık / Thickness	3 mm
Ağırlık / Weight	0,826 kg/m 1,821 lb/m

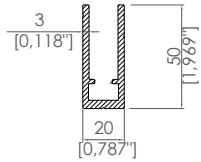

Cam Panel Zincir Profil
Glass Panel Chain Profile

Ürün Kodu / Product Code	3245
Kalınlık / Thickness	3 mm
Ağırlık / Weight	0,981 kg/m 2,1627 lb/m

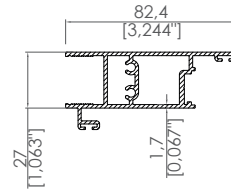

Sabit Cam Yan Kilit Profili
Fixed Glass Side Lock Profile

Ürün Kodu / Product Code	3569
Kalınlık / Thickness	1,7 mm
Ağırlık / Weight	1,257 kg/m 2,771 lb/m

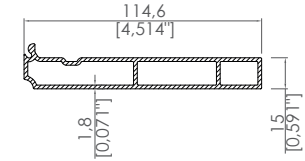

Baza Profili
Sill Profile

Ürün Kodu / Product Code	3066
Kalınlık / Thickness	1,8 mm
Ağırlık / Weight	1,400 kg/m 3,0865 lb/m

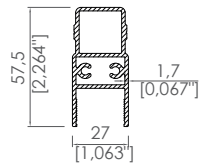

22mm Cam Panel Yan Profil
22mm Glass Panel Side Profile

Ürün Kodu / Product Code	3064
Kalınlık / Thickness	1,7 mm
Ağırlık / Weight	1,030 kg/m 2,2708 lb/m

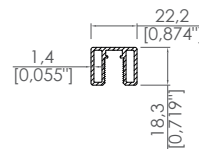

8mm Cam Adaptor
8mm Glass Adapter

Ürün Kodu / Product Code	3065
Kalınlık / Thickness	1,4 mm
Ağırlık / Weight	0,370 kg/m 0,8157 lb/m



ZİP PERDE SİSTEMLERİ

ZIP CURTAIN SYSTEMS

Dikey Perde Sistemleri
Vertical Curtain Systems



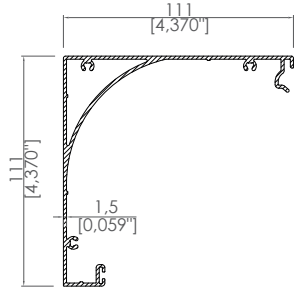

Motor Kutusu Profili
Motor Box Profile

Ürün Kodu / Product Code	2878
Kalınlık / Thickness	1,5 mm
Ağırlık / Weight	1,585 kg/m 3,494 lb/m

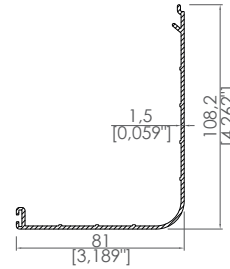

Motor Kutusu Kapağı Profili
Motor Box Cover Profile

Ürün Kodu / Product Code	2875
Kalınlık / Thickness	1,5 mm
Ağırlık / Weight	0,837 kg/m 1,8453 lb/m

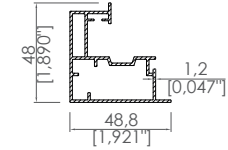

Ray Profili
Rail Profile

Ürün Kodu / Product Code	2877
Kalınlık / Thickness	1,2 mm
Ağırlık / Weight	0,726 kg/m 1,6006 lb/m

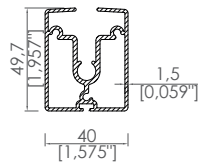

Kumaş Alt Profili
Fabric Bottom Profile

Ürün Kodu / Product Code	2937
Kalınlık / Thickness	1,5 mm
Ağırlık / Weight	1,201 kg/m 2,648 lb/m

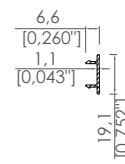

Ray Vida Kapağı
Rail Screw Cover

Ürün Kodu / Product Code	2876
Kalınlık / Thickness	1,1 mm
Ağırlık / Weight	0,084 kg/m 0,1852 lb/m

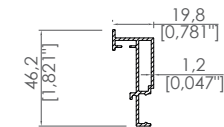

Ray Kapağı Profil
Rail Cover Profile

Ürün Kodu / Product Code	2874
Kalınlık / Thickness	1,2 mm
Ağırlık / Weight	0,382 kg/m 0,8422 lb/m

ZİP PERDE SİSTEMLERİ
ZIP CURTAIN SYSTEMS

Yatay Perde Sistemleri
Horizontal Curtain Systems

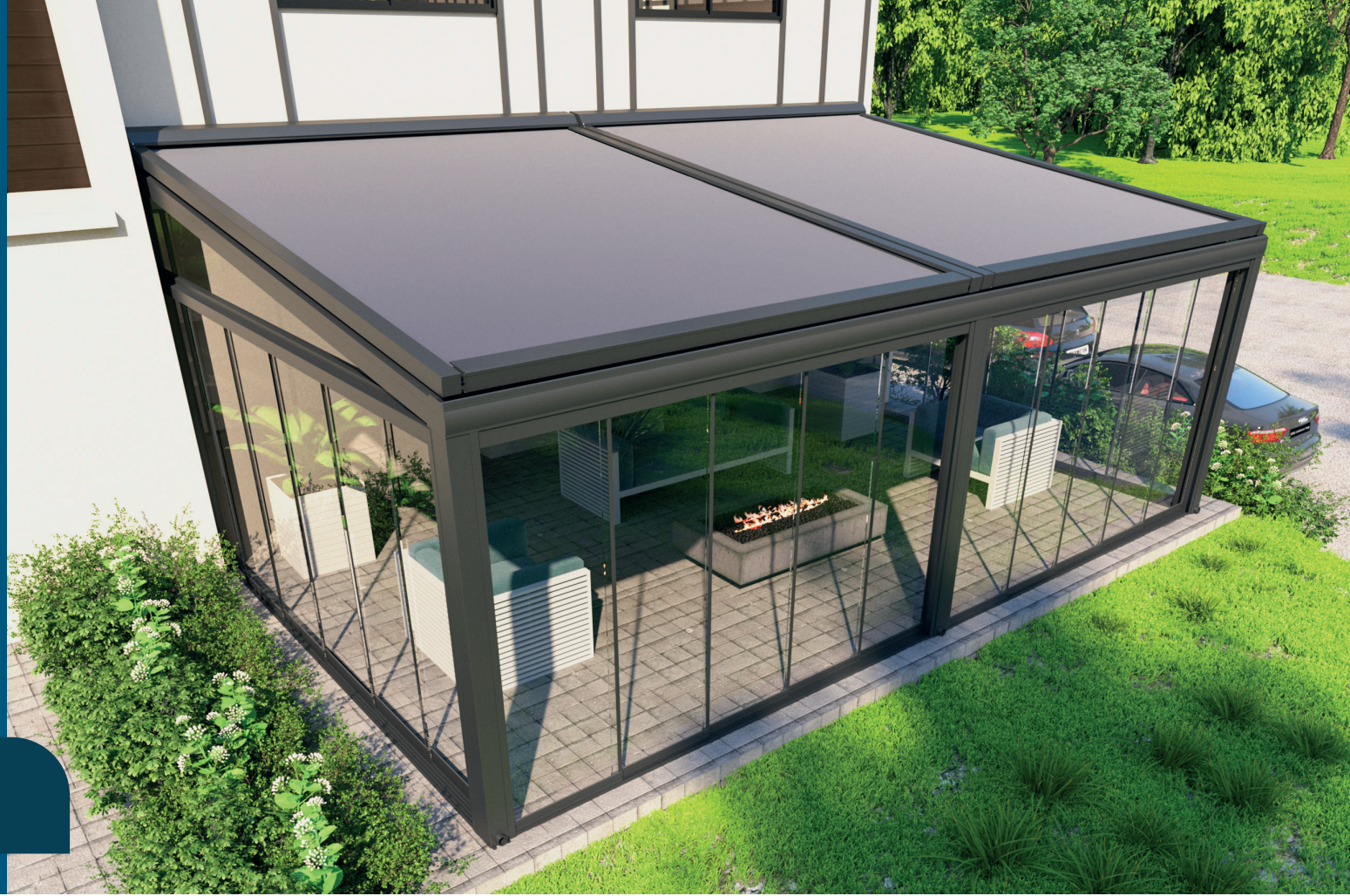

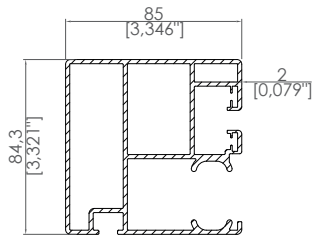

Ray Profili
Rail Profile

Ürün Kodu / Product Code	3178
Kalınlık / Thickness	2 mm
Ağırlık / Weight	2,981 kg/m 6,572 lb/m

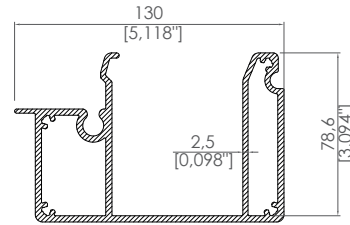

Kumaş Ön Profil
Fabric Front Profile

Ürün Kodu / Product Code	3180
Kalınlık / Thickness	2,5 mm
Ağırlık / Weight	3,905 kg/m 8,609 lb/m

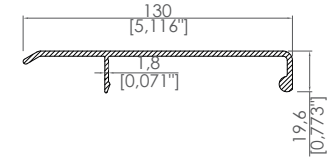

Kumaş Profil Kapak
Fabric Front Profile Cover

Ürün Kodu / Product Code	3179
Kalınlık / Thickness	1,8 mm
Ağırlık / Weight	1,135 kg/m 2,502 lb/m

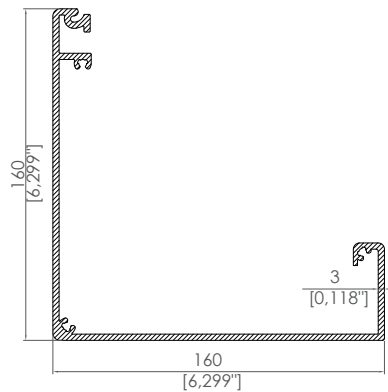

Motor Kutusu
Motor Box

Ürün Kodu / Product Code	3181
Kalınlık / Thickness	3 mm
Ağırlık / Weight	3,580 kg/m 7,893 lb/m

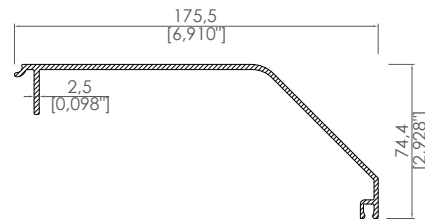

Motor Kutusu Kapağı
Motor Box Cover

Ürün Kodu / Product Code	3182
Kalınlık / Thickness	2,5 mm
Ağırlık / Weight	1,550 kg/m 3,417 lb/m

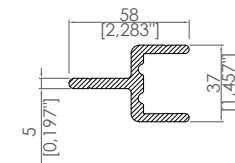

Makara Bağlantı Profili
Pulley Connection Profile

Ürün Kodu / Product Code	3567
Kalınlık / Thickness	5 mm
Ağırlık / Weight	1,390 kg/m 3,0644 lb/m

**BAHÇE ÇİTİ VE
RÜZGAR KIRICI SİSTEMLERİ**
GARDEN FENCE AND
WINDBRAKER SYSTEMS

Bahçe Çiti Profilleri
Garden Fence Profiles



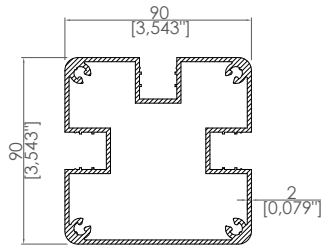

Standart Dikme Profili
Standart Pillar Profile

Ürün Kodu / Product Code	8135
Kalınlık / Thickness	2 mm
Ağırlık / Weight	3,122 kg/m 6,683 lb/m

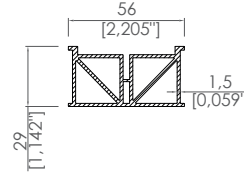

56x29 Deck Destek Profili
56x29 Deck Support Profile

Ürün Kodu / Product Code	8131
Kalınlık / Thickness	1,5 mm
Ağırlık / Weight	1,110 kg/m 2,447 lb/m

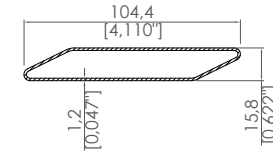

104,4x15,8 Panel Profili
104,4x15,8 Panel Profile

Ürün Kodu / Product Code	3321
Kalınlık / Thickness	1,2 mm
Ağırlık / Weight	0,705 kg/m 1,5543 lb/m

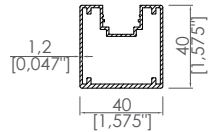

Panel Çerçeve Profili
Panel Frame Profile

Ürün Kodu / Product Code	8281
Kalınlık / Thickness	1,2 mm
Ağırlık / Weight	0,737 kg/m 1,6248 lb/m

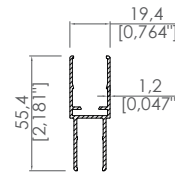

Cam Panel Profili
Glass Panel Profile

Ürün Kodu / Product Code	8181
Kalınlık / Thickness	1,2 mm
Ağırlık / Weight	0,483 kg/m 1,0648 lb/m

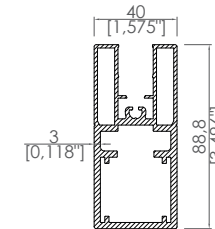

Kapı Çerçeve Profili
Door Frame Profile

Ürün Kodu / Product Code	8153
Kalınlık / Thickness	1,6 mm
Ağırlık / Weight	2,423 kg/m 5,342 lb/m

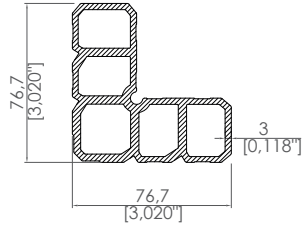

Cam Panel Köşe Takoza
Glass Panel Corner Block Profile

Ürün Kodu / Product Code	2972
Kalınlık / Thickness	1,1 mm
Ağırlık / Weight	3,440 kg/m 7,584 lb/m

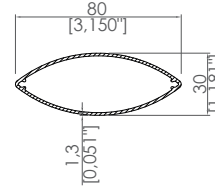

80x30 Güneş Kırıcı Profili
80x30 Sun Breaker Profile

Ürün Kodu / Product Code	2596
Kalınlık / Thickness	1,3 mm
Ağırlık / Weight	0,626 kg/m 1,38 lb/m

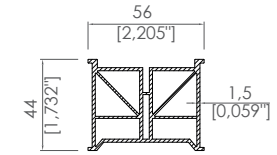

56x44 Deck Destek Profili
56x44 Deck Support Profile

Ürün Kodu / Product Code	8130
Kalınlık / Thickness	1,5 mm
Ağırlık / Weight	1,377 kg/m 3,036 lb/m

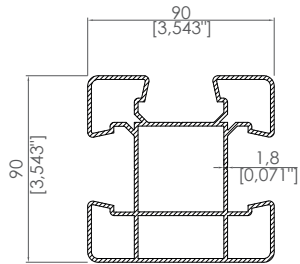

Dikme Profili
Pillar Profile

Ürün Kodu / Product Code	3528
Kalınlık / Thickness	1,8 mm
Ağırlık / Weight	2,992 kg/m 6,596 lb/m

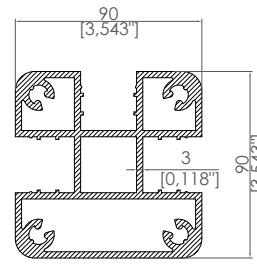

Dikme Profili
Pillar Profile

Ürün Kodu / Product Code	3421
Kalınlık / Thickness	3 mm
Ağırlık / Weight	2,512 kg/m 5,538 lb/m

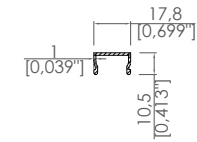

Dikme Kapak Profili
Pillar Cover Profile

Ürün Kodu / Product Code	3406
Kalınlık / Thickness	1 mm
Ağırlık / Weight	0,117 kg/m 0,3902 lb/m



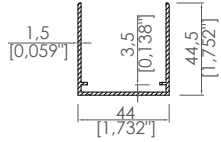

Panel Dikme Bağlantı Profili
Panel - Pillar Connection

Ürün Kodu / Product Code	3726
Kalınlık / Thickness	1,5 mm
Ağırlık / Weight	0,545 kg/m 1,2015 lb/m

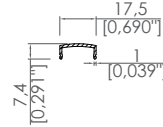

Standart Dikme Kapak Profili
Standart Pillar Cover Profile

Ürün Kodu / Product Code	8136
Kalınlık / Thickness	1 mm
Ağırlık / Weight	0,090 kg/m 0,1984 lb/m

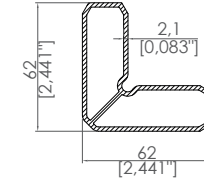

Kasa Köşe Takoğu Profili
Frame Corner Block Profile

Ürün Kodu / Product Code	2971
Kalınlık / Thickness	2,1 mm
Ağırlık / Weight	1,442 kg/m 3,179 lb/m

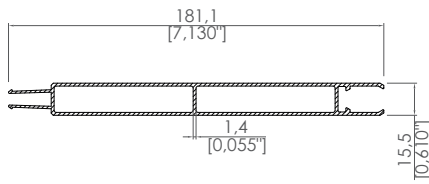

180x15 Panel Profili
180x15 Panel Profile

Ürün Kodu / Product Code	8138
Kalınlık / Thickness	1,4 mm
Ağırlık / Weight	1,520 kg/m 3,351 lb/m

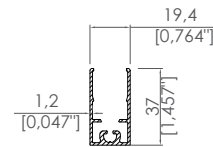

Panel Üst Profili
Panel Top Profile

Ürün Kodu / Product Code	8137
Kalınlık / Thickness	1,2 mm
Ağırlık / Weight	0,406 kg/m 0,895 lb/m

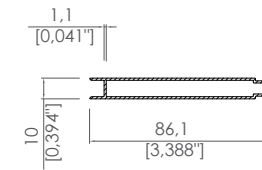

86x10 Panel Profili
86x10 Panel Profile

Ürün Kodu / Product Code	2399
Kalınlık / Thickness	1,1 mm
Ağırlık / Weight	0,537 kg/m 1,184 lb/m

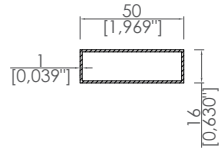
Kutu Profili
Box Profile

Ürün Kodu / Product Code	2609
Kalınlık / Thickness	1 mm
Ağırlık / Weight	0,350 kg/m 0,7716 lb/m

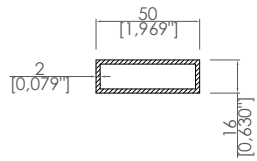
Kutu Profili
Box Profile

Ürün Kodu / Product Code	3704
Kalınlık / Thickness	2 mm
Ağırlık / Weight	0,672 kg/m 1,4815 lb/m



**BAHÇE ÇİTİ VE
RÜZGAR KIRICI SİSTEMLERİ**
GARDEN FENCE AND
WINDBRAKER SYSTEMS

Rüzgar Kırıcı Profilleri
Windbraker Profiles



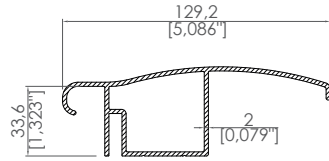

Küpeşte Profili
Handrail Profile

Ürün Kodu / Product Code	3040
Kalınlık / Thickness	2 mm
Ağırlık / Weight	1,572 kg/m 3,466 lb/m

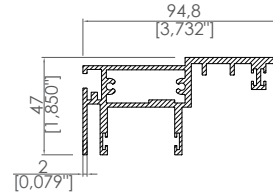

Sabit Panel Dikme Profili
Fixed Panel Pillar Profile

Ürün Kodu / Product Code	3039
Kalınlık / Thickness	2 mm
Ağırlık / Weight	2,110 kg/m 4,652 lb/m

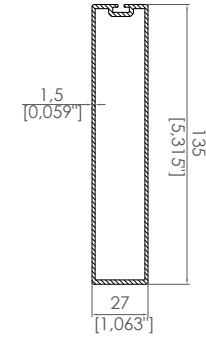

Ağırlıklı Profili
Weight Profile

Ürün Kodu / Product Code	3492
Kalınlık / Thickness	1,5 mm
Ağırlık / Weight	1,415 kg/m 3,1195 lb/m

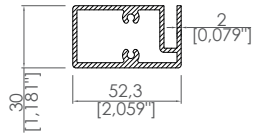

Cam Panel Alt Profili
Glass Panel Bottom Profile

Ürün Kodu / Product Code	3042
Kalınlık / Thickness	2 mm
Ağırlık / Weight	1,210 kg/m 2,6676 lb/m

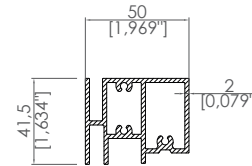

Hareketli Cam Yan Profil
Movable Glass Side Profile

Ürün Kodu / Product Code	3041
Kalınlık / Thickness	2 mm
Ağırlık / Weight	1,450 kg/m 3,197 lb/m

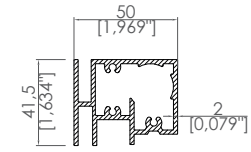

Pistonlu Dikme Profili
Pillar Profile For Piston

Ürün Kodu / Product Code	3043
Kalınlık / Thickness	2 mm
Ağırlık / Weight	1,390 kg/m 3,0644 lb/m





KENAN METAL®



kenanmetal.com | info@kenanmetal.com | +90 212 485 60 35

Genel Merkez : İosb Mh. Atatürk Blv. Mahmut Torun İş Merkezi No: 54 Kat: 134490 İkitelli Osb / Başakşehir / İstanbul
Fabrika : Velimeşe Mahallesi, Kandil Caddesi, 329 Sokak, Dış Kapı No:7 Ergene / Tekirdağ

