

Alüminyum'un Sanata Dönüşümü...



Aluminum Profile Systems

ISI CAMLI SÜRME SİSTEMİ
SLIDING DOUBLE GLASS SYSTEM



www.kenanmetal.com

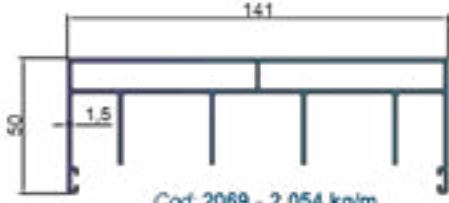

Cod: 2069 - 2,054 kg/m
Üst Kasa Profili

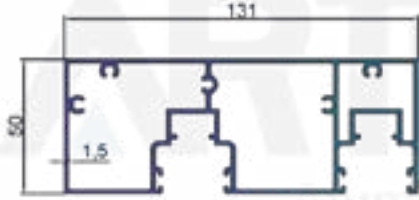

Cod: 2066 - 2,414 kg/m
Yan Kasa Profili

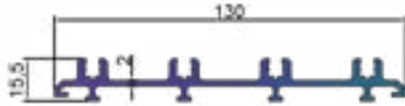

Cod: 2070 - 1,480 kg/m
Alt Kasa Profili



Cod: 2568 - 1,423 kg/m
Alt Baza Profili



Cod: 2149 - 1,160 kg/m
Orta Birleştirme Profili

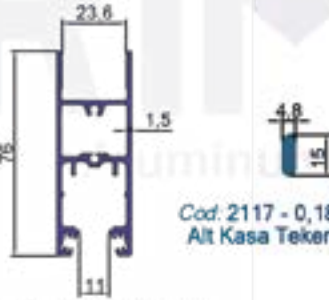

Cod: 2117 - 0,185 kg/m
Alt Kasa Teker Profili

Cod: 2565 - 1,205 kg/m
Alt Çerçeve Profili

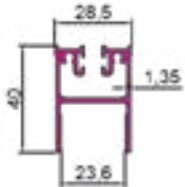

Cod: 2071 - 0,703 kg/m
Üst Çerçeve Profili

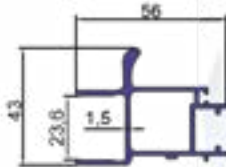

Cod: 2068 - 0,878 kg/m
Kulplu Yan Çerçeve Profili

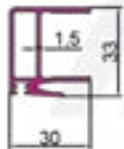

Cod: 2065 - 0,585 kg/m
Yan Çerçeve Profili



Cod: 2067 - 0,186 kg/m
Yan Kasa Profili Kapağı

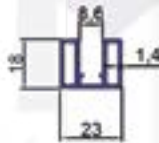

Cod: 2150 - 0,375 kg/m
8 mm Cam Adaptör Profili

DÖRTLÜ SİSTEM KESİTİ
FOUR SYSTEM SECTION

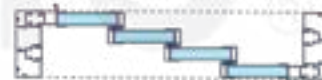
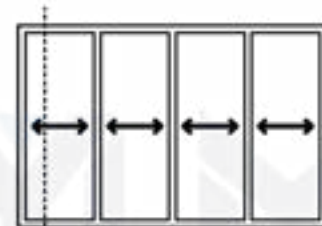
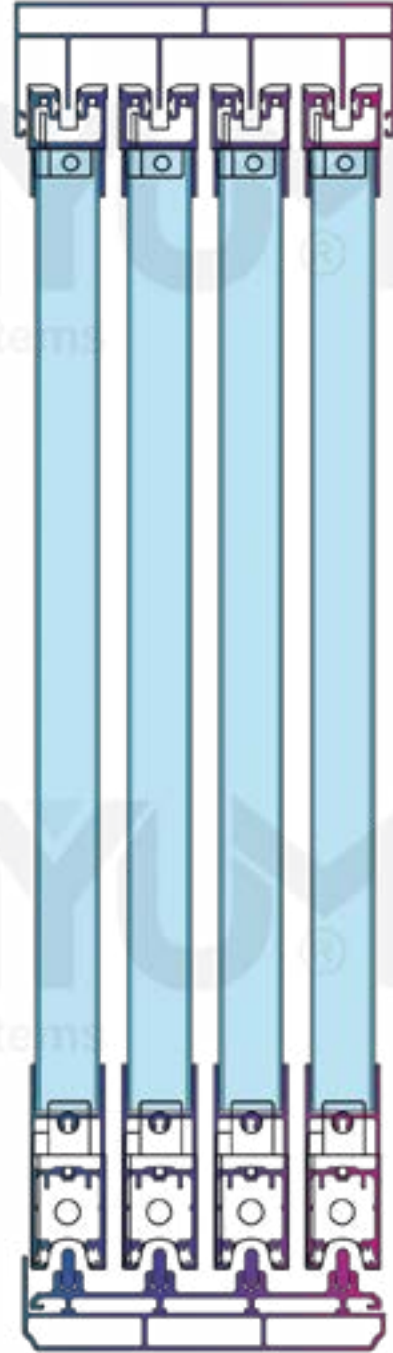

İKİLİ SİSTEM
BINARY SYSTEM

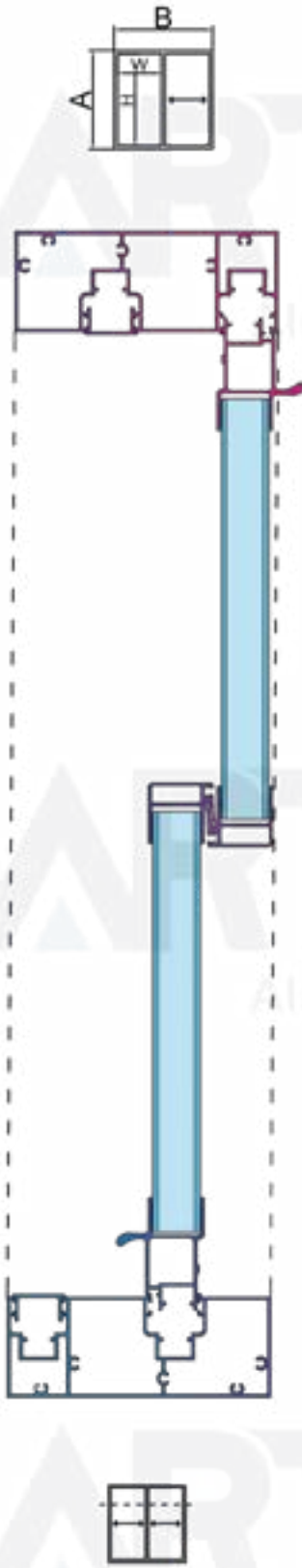

ÜÇLÜ SİSTEM
TRIPLE SYSTEM

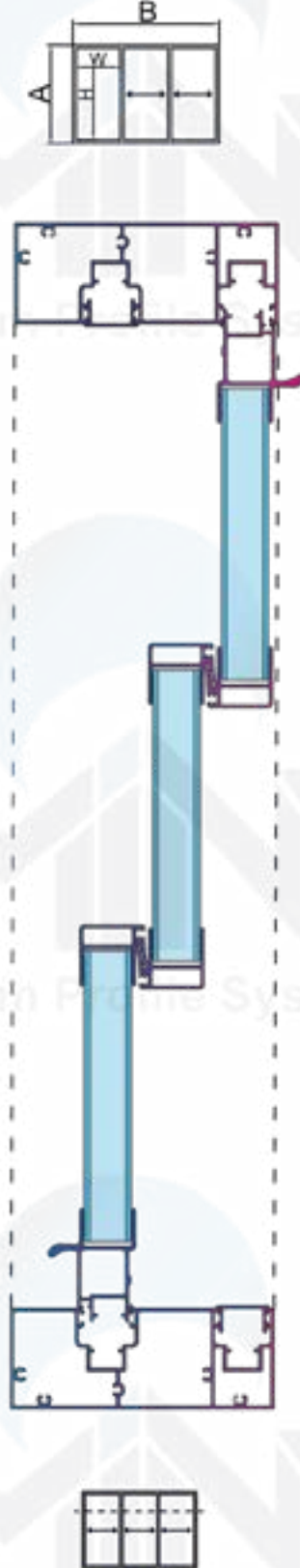

DÖRTLÜ SİSTEM
QUATERNARY SYSTEM

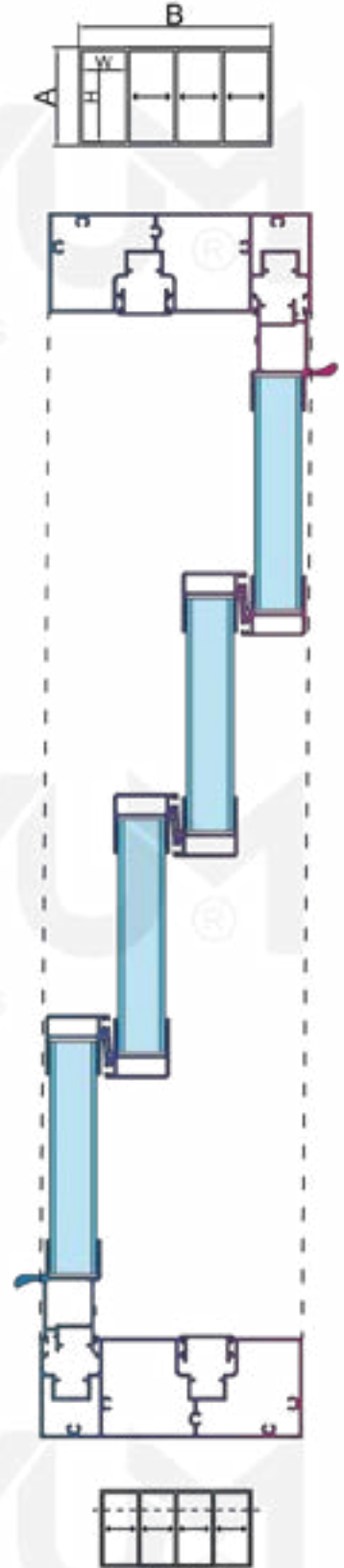



BEŞLİ SİSTEM
QUINTET SYSTEM

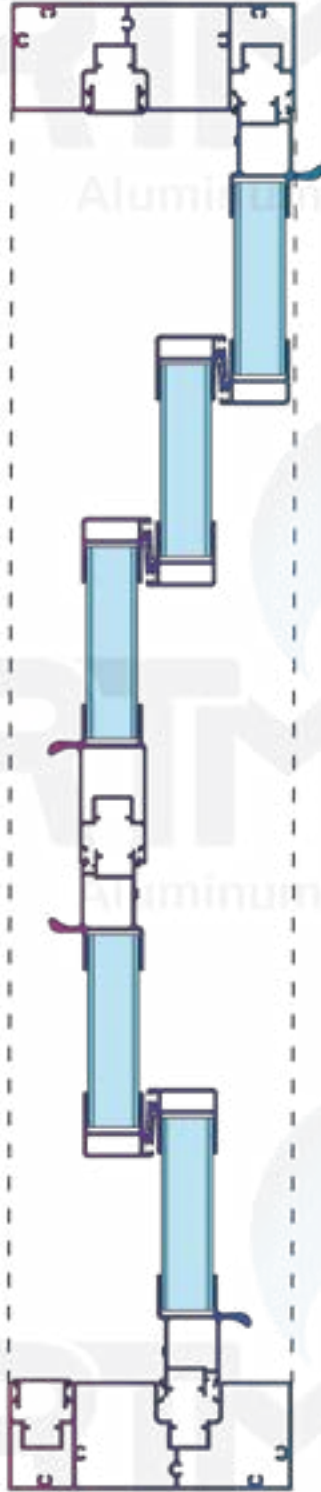
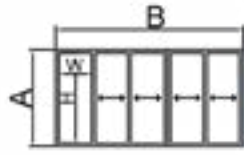

ALTILI SİSTEM
SIX SYSTEM

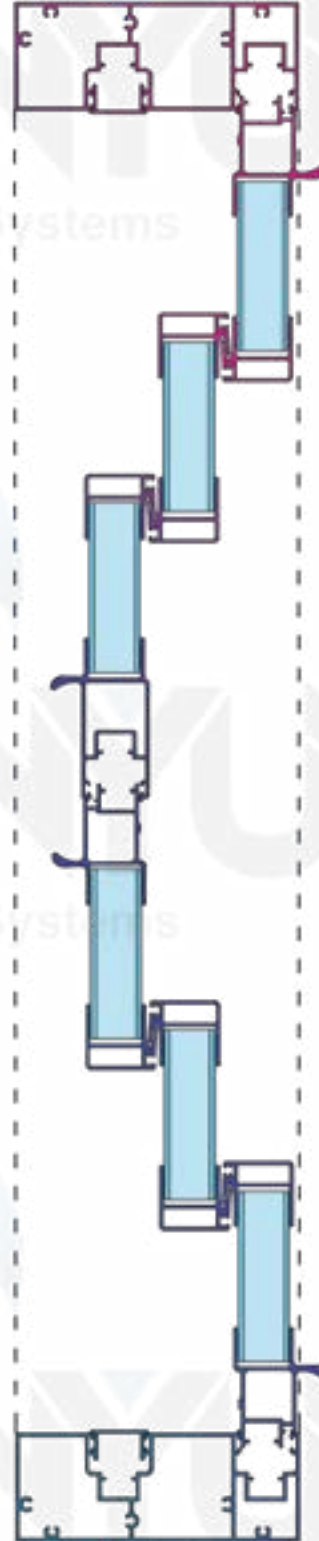
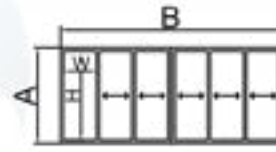



YEDİLİ SİSTEM
SEVEN SYSTEM

SEKİZLİ SİSTEM
OCTAL SYSTEM

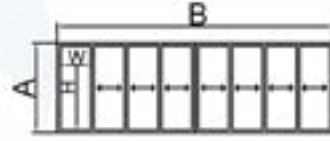
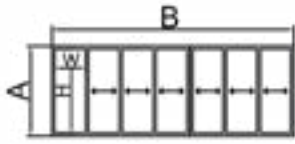



Yan Kasa Profili
Side Sash Profile

Product Code: 2066

Weight kg/m: 2,414
(50 x 131 x 1,5mm)

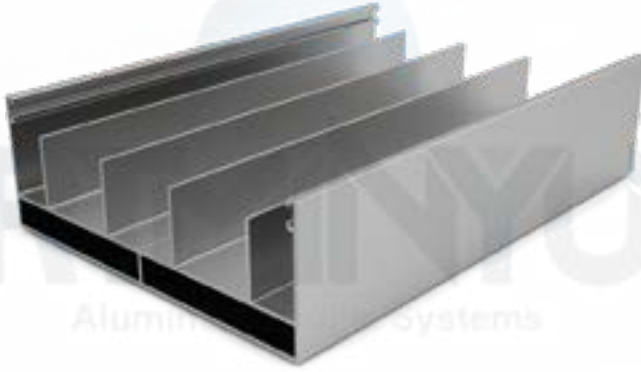

Üst Kasa Profili
Upper Sash Profile

Product Code: 2069

Weight kg/m: 2,054
(50 x 141 x 1,5mm)

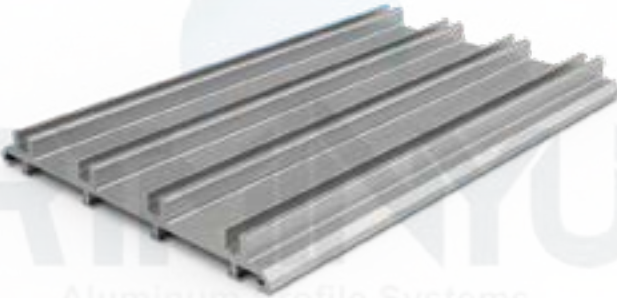

Alt Kasa Profili
Bottom Sash Profile

Product Code: 2070

Weight kg/m: 1,480
(15,5 x 130 x 2mm)

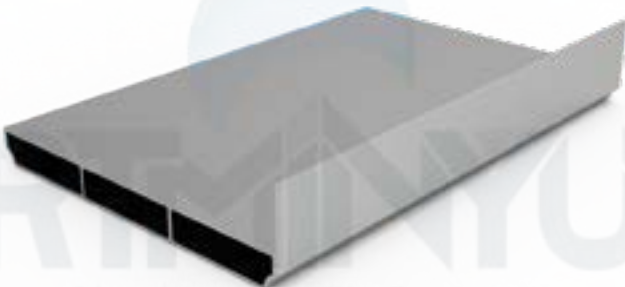

Alt Baza Profili
Lower Base Profile

Product Code: 2566

Weight kg/m: 1,423
(35 x 134 x 1,6mm)



Orta Birleştirme Profili
Two System Connection Profile

Product Code: 2149

Weight kg/m: 1,160
(45,5 x 74 x 1,4mm)

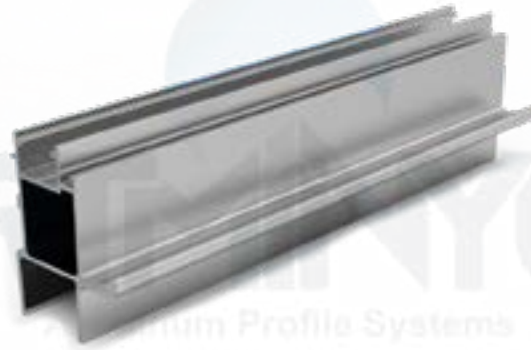

Kulplu Yan Çerçeve Profili 22mm
*Side Frame Profile With Handle
For 22 mm Glass*

Product Code: 2068

Weight kg/m: 0,878
(43 x 56 x 1,5mm)

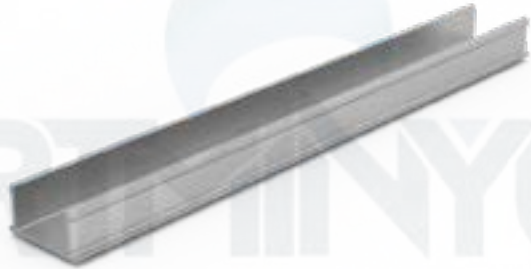

Yan Kasa Profili Kapağı
Cover For Side Sash Profile

Product Code: 2067

Weight kg/m: 0,186
(13,6 x 27 x 1,3mm)

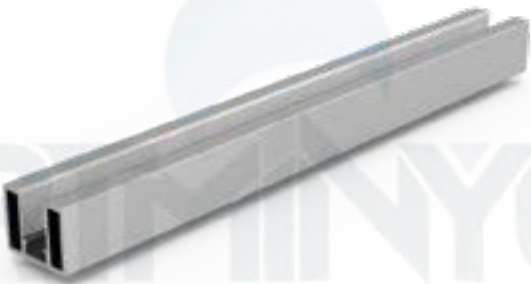

8 mm Cam Adaptör Profili
8 mm Glass Convertor Profile

Product Code: 2150

Weight kg/m: 0,375
(18 x 23 x 1,4mm)



Alt Çerçeve Profili 22 mm
*Bottom Frame Profile
For 22 mm Glass*

Product Code: 2565

Weight kg/m: 1,205
(23,6 x 76 x 1,5mm)

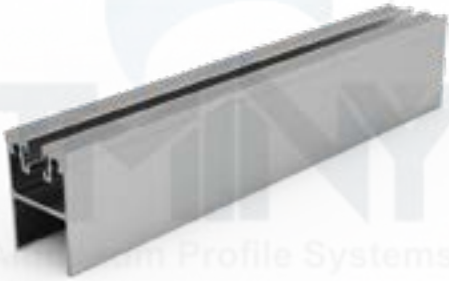

Üst Çerçeve Profili 22 mm
*Upper Frame Profile
For 22 mm Glass*

Product Code: 2071

Weight kg/m: 0,703
(28,5 x 40 x 1,35mm)

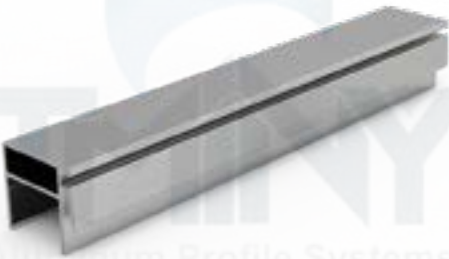

Yan Çerçeve Profili 22 mm
Side Frame Profile For 22 mm Glass

Product Code: 2065

Weight kg/m: 0,585
(30 x 33 x 1,5mm)



Alt Kasa Teker Profili
Bottom Sash Profile For Roll

Product Code: 2117

Weight kg/m: 0,185
(4,8 x 15 mm)



SÜRME CAM SİSTEMİ / SLIDING GLASS SYSTEM



SRM-01 SÜRME TAKIM SAĞ / SRM-01 SLIDING SET RIGHT

SRM-02 SÜRME TAKIM SOL / SRM-02 SLIDING SET LEFT



Kasa Alt Köşe Takoğu
Case Lower Corner Wedge

Product Code: Srm-05
Box Piece: 2



Kasa Üst Köşe Takoğu
Case Top Corner Wedge

Product Code: Srm-06
Box Piece: 2



Sürme Teker Çiftli Alt
Sliding Wheel Double Bottom

Product Code: Srm-07
Box Piece: 8



Kollu Kanat Üst Plastik
Arm Wing Top Plastic

Product Code: Srm-08
Box Piece: 2



Kollu Kanat Alt Plastik
Arm Wing Lower Plastic

Product Code: Srm-09
Box Piece: 2



Tırnaklı Kanat Üst Plastik
Spiked Wing Top Plastic

Product Code: Srm-10
Box Piece: 6



Üst Teker
Upper Wheel

Product Code: Srm-11
Box Piece: 16



Tırnaklı Kanat Alt Plastik
Spiked Wing Lower Plastic

Product Code: Srm-18
Box Piece: 2



İspanyolet
Espagnolette

Product Code: Srm-03
Box Piece: 2



İspanyolet Karşılığı
Espagnolette Equivalent

Product Code: Srm-04
Box Piece: 6



Kiltsiz Kol
Unlocked Handle

Product Code: Srm-12
Box Piece: 1



Kilitli Kol
locked Handle

Product Code: Srm-13
Box Piece: 1



Orta Birleştirme Pilastik
Medium Joining Plastic

Product Code: Srm-17
Box Piece: 1



EPDM Conta
EPDM Bolt

Product Code: Srm-16
Roll: 300 mt.



6.7x550 Kıl Fitol
6.7x550 Brush

Product Code: Srm-14
Roll: 375 mt.
Box Piece: 1500 mt.



4.8x450 Kıl Fitol
4.8x450 Strip Brush

Product Code: Srm-15
Roll: 550 mt.
Box Piece: 2200 mt.





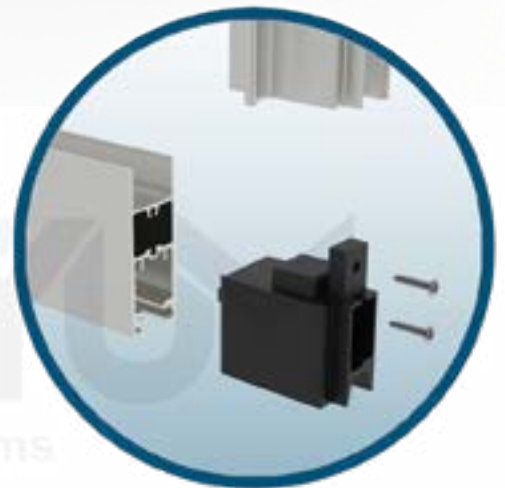
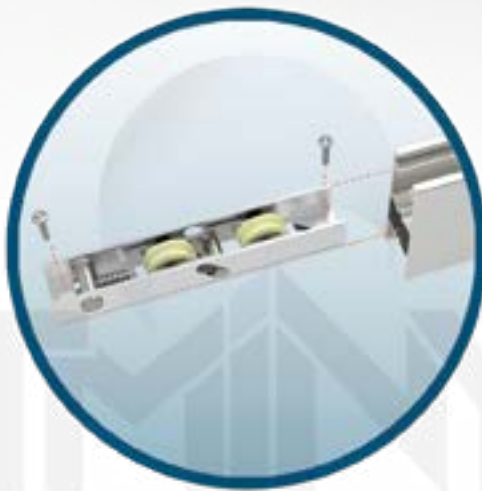

Aluminum Profile Systems

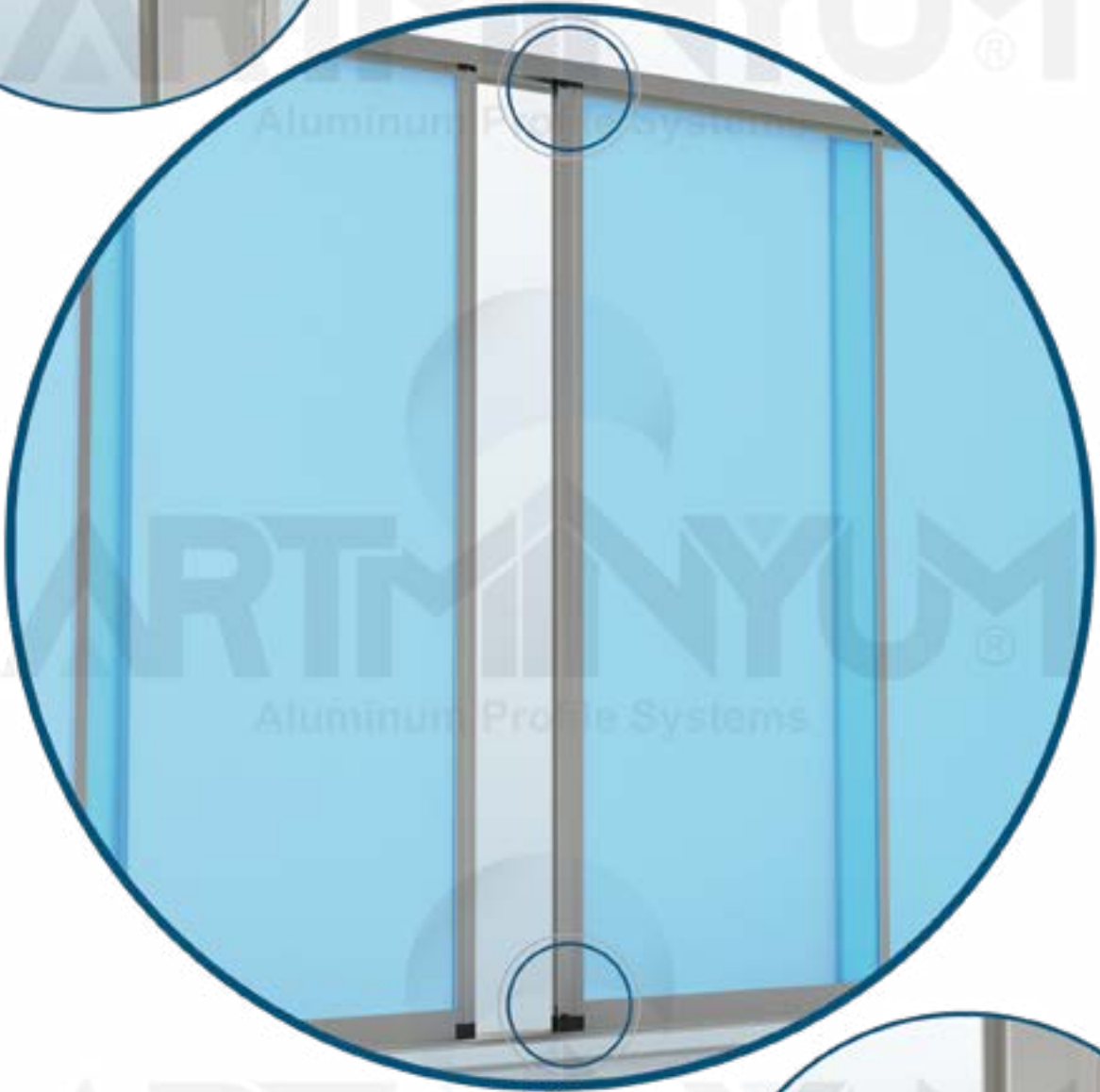



ARTMINYUM
Aluminum Profile Systems



KENAN METAL®

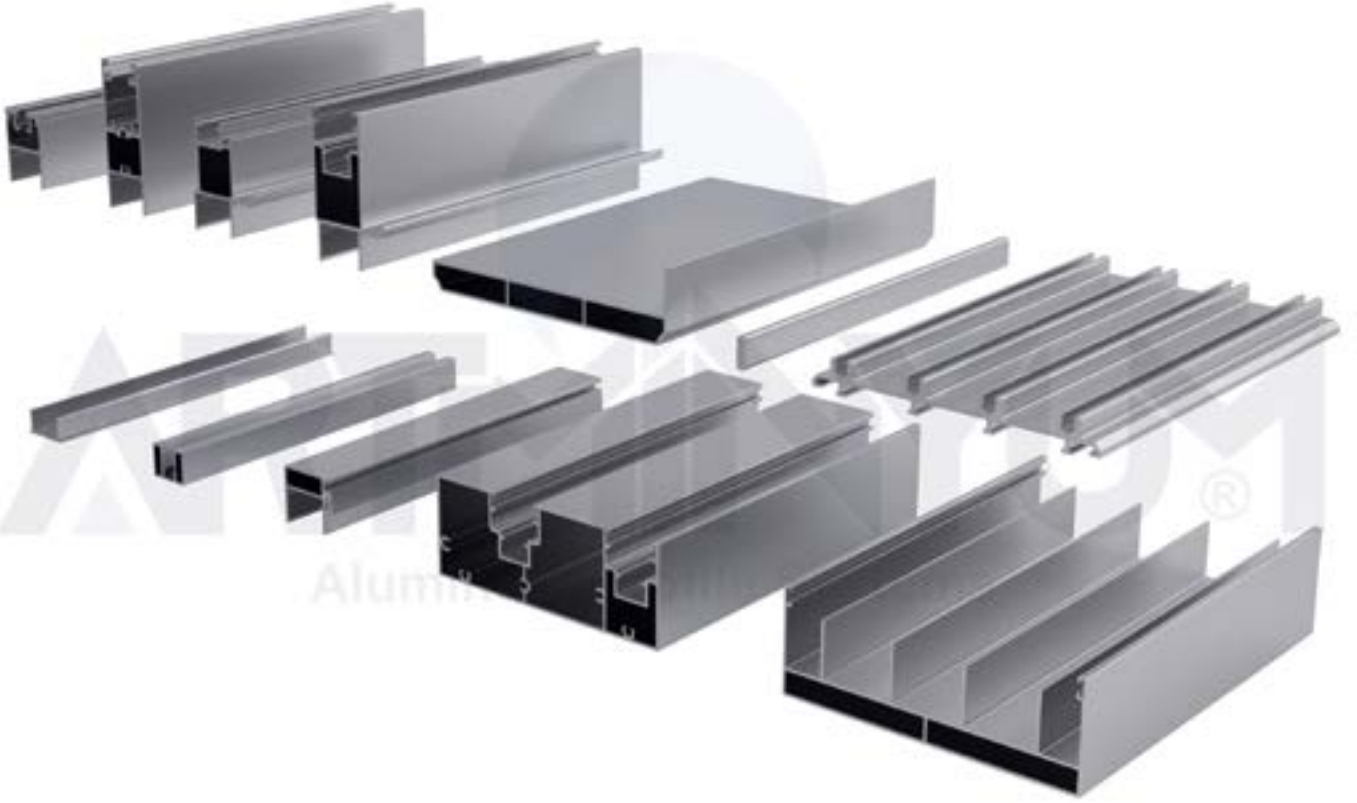

KENAN METAL ALÜMİNYUM PROFİL SAN. TİC. LTD. ŞTİ.



Merkez: Atatürk Bulvarı Mahmut Torun Plaza No:54
Dışkapı No: 2/7 İç Kapı No:2 Başakşehir / İSTANBUL
Tel: +90 212 485 60 35 Fax: +90 212 485 60 46
Fabrika: Velimeşe Mah. Kandil Cad. 329 Sk. No:7 Ergene / Tekirdağ
info@kenanmetal.com - www.kenanmetal.com