

KENAN METAL

ARTINYUM®

ARTINYUM®

Aluminum Profile Systems

LOTUS TEMİZLENEBİLİR GİYOTİN SİSTEMİ

Lotus Cleansable System

LOTUS TEMİZLENEBİLİR GİYOTİN SİSTEMİ

Lotus Cleansable System



Giyotin cam sistemi, genellikle büyük cam yüzeylerin açılabilir pencere veya kapı olarak kullanılabilmesini sağlayan bir tür cam sistemi veya cam düzenlemesini ifade eder. Bu sistem, özellikle ticari binalarda, otellerde veya büyük yapılarda tercih edilen bir cam açma mekanizmasıdır.

Giyotin cam sistemi, mekanın doğal havalandırılması veya büyük cam yüzeylerin geçiş açıklıkları olarak kullanılabilmesi için idealdir. Özellikle güzel hava koşullarında iç ve dış mekan arasındaki geçişi kolaylaştırır.

Alüminyum giyotin sistemleri, modern bina tasarımında popüler bir tercih haline gelmiştir. Estetik açıdan çekici ve dayanıklı olmaları, birçok yapı projesinde tercih edilmelerinin nedenlerindedir. Ayrıca, enerji tasarrufu ve iç mekan konforunu artırma potansiyeli sunarlar.

The guillotine glass system generally refers to a type of glass system or arrangement that allows large glass surfaces to be used as operable windows or doors. This system is a preferred glass opening mechanism, particularly in commercial buildings, hotels, or large structures.

The guillotine glass system is ideal for natural ventilation of the space or for use as large glass openings. It facilitates the transition between indoor and outdoor environments, especially in good weather conditions.

Aluminum guillotine systems have become a popular choice in modern building design. Their aesthetic appeal and durability are among the reasons they are preferred in many construction projects. Additionally, they offer the potential to increase energy efficiency and indoor comfort.



Interior of Art

İç Yaşamda Sanat

Aluminum Profile Systems



Alüminyum Profil Sistemleri

RAL renk standardına göre seçtiğiniz tüm renkler uygulanabilir.

Colouring of your choice, according to the RAL colour standard.

Yağmur ve rüzgar gibi hava şartlarına son derece dayanıklıdır.

It is extremely resistant to weather conditions such as rain and wind.

Materyal // 6063 T5 alüminyum, paslanmaz çelik ve derlin.

Materials // 6063 T5 aluminum, stainless steel and derlin.

- Temizlenebilir giyotin cam sistemleri, cam panelleri yatay bir eksenle döndürerek temizlik işlemini kolaylaştırır. Bu sistem sayesinde cam yüzeylere erişim daha rahat ve güvenli hale gelir. Temizlik yapmak için cam panelleri indirip çıkarmak veya dışarıya çıkarmak gerekmez.
- Sistem komple kapalıyken camların iç yüzeyleri rahatlıkla silinebilmektedir.
- "Cleanable guillotine glass systems facilitate the cleaning process by rotating the glass panels on a horizontal axis. This system makes accessing glass surfaces easier and safer. There is no need to lower or remove the glass panels or go outside to clean.
- The inner surfaces of the glass can be easily cleaned when the system is fully closed."



Aluminum Profile Systems

Artminyum



Sistem kapalı konumdayken , en alttaki cam kol yardımıyla içe açılarak dış yüzeyinin temizliği yapılabilir.

Ortada bulunan cam, en alttaki cam açık konuma geldikten sonra , açılarak dış yüzeyinin temizliği yapılabilir.

Sistemin tekrar normal açılıp kapanma konumuna alınabilmesi için kilit mekanizması kapalı konuma getirilmelidir.

Sistem komple açık konumdayken ise en üstteki camın dış yüzeyinin temizliği yapılabilir.

While the system is in the closed position, the bottommost glass can be opened inwards using the lever to clean its outer surface.

The glass in the middle can be opened for cleaning its outer surface after the bottommost glass is opened in the open position.

To return the system to its normal open and closed position, the locking mechanism must be closed.

When the system is fully open, the outer surface of the topmost glass can be cleaned.







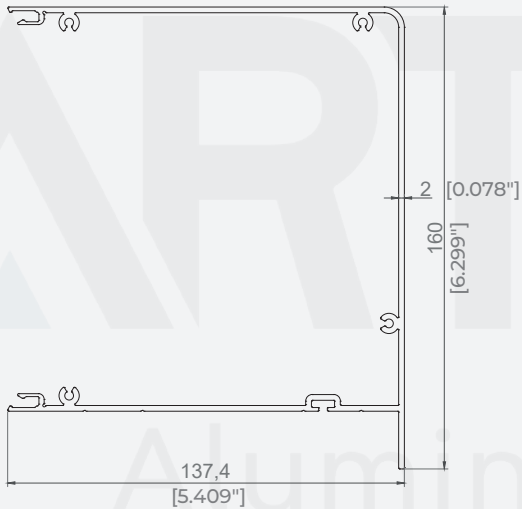

Motor Kutusu Profili / Motor Box Profile

Ürün Kodu / Product Code	37272
Ağırlık / Weight	2,700 kg/m 5,952 lb/m

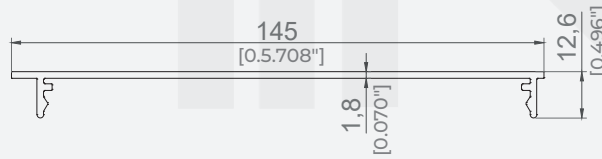
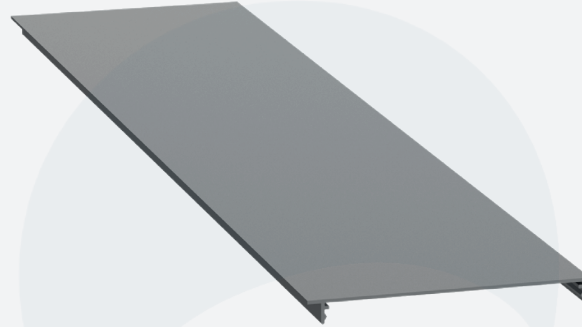

Motor Kutusu Kapak Profili / Motor Box Cover Profile

Ürün Kodu / Product Code	37271
Ağırlık / Weight	0,847 kg/m 1,867 lb/m

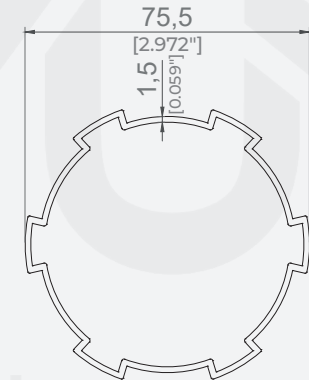

Motor Tüp Profili / Motor Tube Profile

Ürün Kodu / Product Code	5312
Ağırlık / Weight	1,100 kg/m 2,425 lb/m

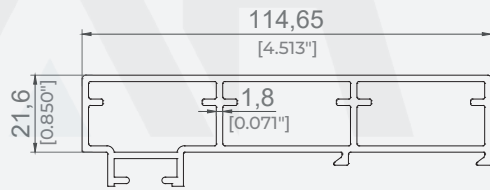

Yan Ray Profili / Side Rail Profile

Ürün Kodu / Product Code	3570
Ağırlık / Weight	1,772 kg/m 3,906 lb/m

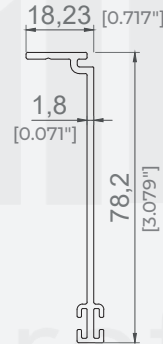
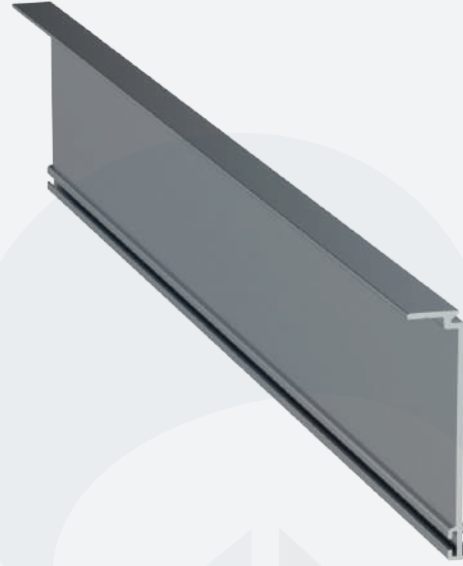

Yan Ray Orta Profil / Side Rail Middle Profile

Ürün Kodu / Product Code	3073
Ağırlık / Weight	0,540 kg/m 1,190 lb/m

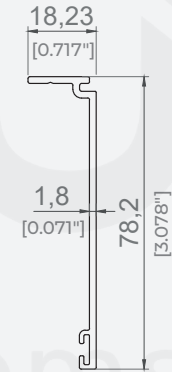
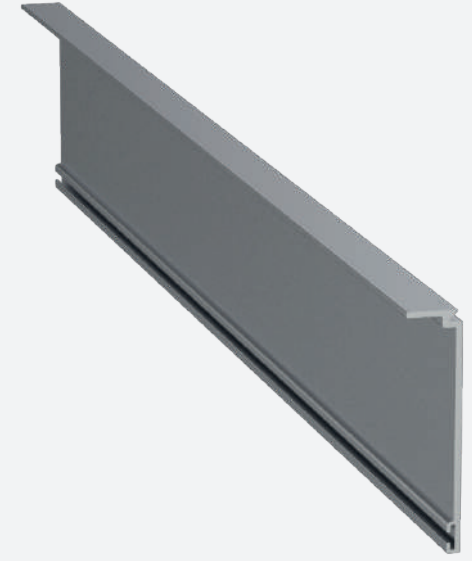

Yan Ray Kapak Profili / Side Rail Cover Profile

Ürün Kodu / Product Code	3071
Ağırlık / Weight	0,510 kg/m 1,124 lb/m

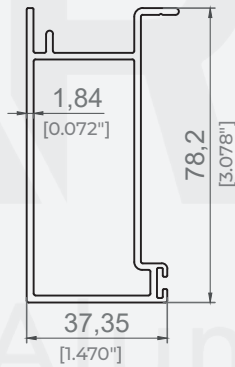

Yan Ray Dikme Profili / Side Rail Pillar Profile

Ürün Kodu / Product Code	3072
Ağırlık / Weight	1,170 kg/m 2,579 lb/m

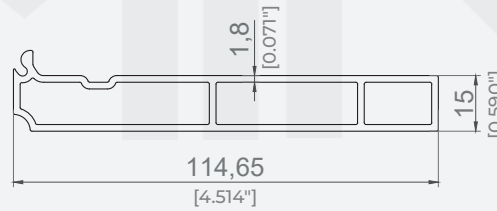
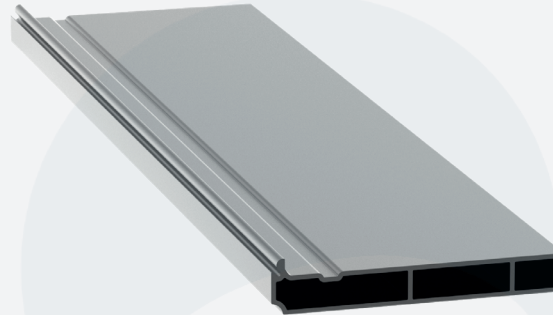

Baza Profili / Sill Profile

Ürün Kodu / Product Code	3066
Ağırlık / Weight	1,400 kg/m 3,086 lb/m

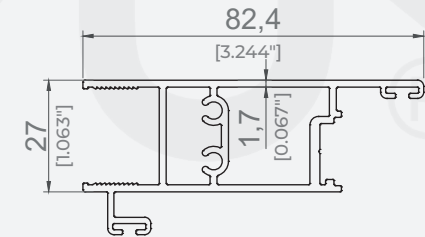

Sabit Cam Yan Kilit Profili / Fixed Glass Side Lock Profile

Ürün Kodu / Product Code	3569
Ağırlık / Weight	1,257 kg/m 2,771 lb/m

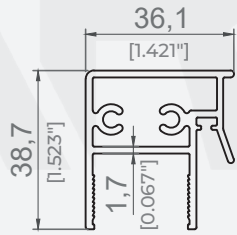
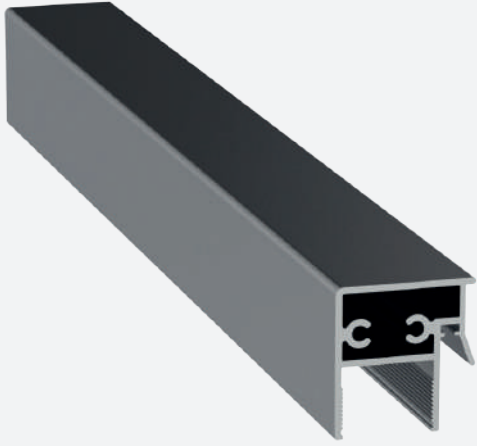

22mm Cam Panel Çekici Profili / 22mm Glass Panel Puller Profile

Ürün Kodu / Product Code	3068
Ağırlık / Weight	0,860 kg/m 1,896 lb/m

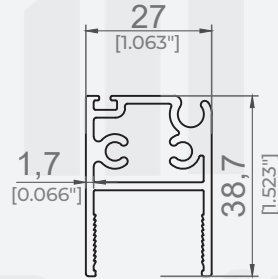

22mm Trabzan Profili / 22mm Handrail Profile

Ürün Kodu / Product Code	3067
Ağırlık / Weight	0,800 kg/m 1,763 lb/m

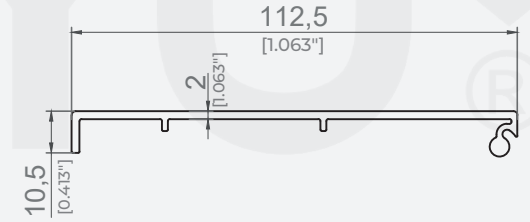

Trabzan Kapak Profili / Handrail Cover Profile

Ürün Kodu / Product Code	3070
Ağırlık / Weight	0,770 kg/m 1,697 lb/m

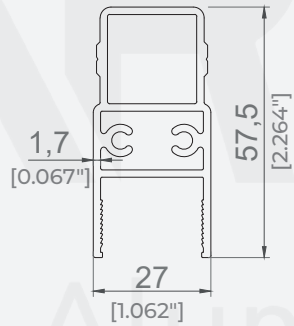

22mm Cam Panel Yan Profil / 22mm Glass Panel Side Profile

Ürün Kodu / Product Code	3064
Ağırlık / Weight	1,030 kg/m 2,271 lb/m

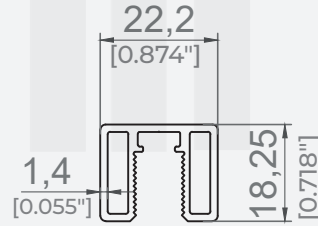

8mm Cam Adaptör / 8mm Glass Adapter

Ürün Kodu / Product Code	3065
Ağırlık / Weight	0,370 kg/m 0,8157 lb/m



Lotus Zincirli Aksesuar Seti Yeni
Kod: LTS-1Y

Lotus Chain Accessories New
Set
Code: LTS-1Y



Cam Köşe Takoza
Glass Corner Wedge

Kod / Code	LTS-8
Adet / Piece	2



Tırnaklı Köşe Takoza
Nailed Corner Wedge

Kod / Code	LTS-8
Adet / Piece	6



Sabit Köşe Takoza Üst
Fixed Corner Wedge Top

Kod / Code	LTS-8
Adet / Piece	2



Dikme Ray Tırnak Plastiği
Sewing Rail Nail Plastic

Kod / Code	LTS-8
Adet / Piece	2



Mafsal Plastiği
Joint Plastic

Kod / Code	LTS-8
Adet / Piece	2

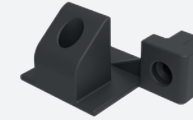

Sağ Panel Sabitleyici Plastik
Panel Fixing Plastic Right

Kod / Code	LTS-1Y
Adet / Piece	1



Sol Panel Sabitleyici Plastik
Panel Fixing Plastic Left

Kod / Code	LTS-1Y
Adet / Piece	1



Teker Sabitleyici Plastik
Wheel Fixing Plastic

Kod / Code	LTS-1Y
Adet / Piece	8



Sabit Köşe Takoza Alt
Glass Corner Wedge Bottom

Kod / Code	LTS-8
Adet / Piece	2



Plastik Tapa
Plastic Plug

Kod / Code	LTS-8
Adet / Piece	20



Alt Baza Plastiği
Base And Side Profile

Kod / Code	LTS-8
Adet / Piece	2

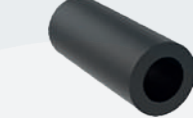

Zincir Aktarım Plastiği
Chain Transfer Plastic

Kod / Code	LTS-8
Adet / Piece	2



Boru Başı
Pipe Head

Kod / Code	LTS-8
Adet / Piece	1

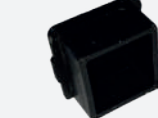

Profil Kapak Plastiği
Profile Cover Plastic

Kod / Code	LTS-8
Adet / Piece	6



Açılır Cam Sabitleme Plastiği
Glass Fixing Plastic

Kod / Code	LTS-8
Adet / Piece	2



Rulmanlı Teker
Bearing Wheel

Kod / Code	LTS-1Y
Adet / Piece	16

Boyandırılabilir
Can be Painted



Tüp Motor Kapağı
Tube Motor Cover

Kod / Code	LTS-1Y
Adet / Piece	2



Rulman Yatağı
Bearing Fastening

Kod / Code	LTS-1Y
Adet / Piece	1



Rulman Kelepçesi
Bearing Clamp

Kod / Code	LTS-1Y
Adet / Piece	1



Motor Kutusu Kızağı
Motor Box Sled

Kod / Code	LTS-1Y
Adet / Piece	2



Zincir
Chain

Kod / Code	GYT-19
Adet / Piece	5 meters



Lotus Dişli
Lotus Gear

Kod / Code	LTS-6
Adet / Piece	2



Teker Sabitleme Vidası
Wheel Fixing Screw

Kod / Code	LTS-1Y
Adet / Piece	16



Lotus İspanyolet
Lotus Espagnolette

Kod / Code	LTS-1Y
Adet / Piece	2



Zincir Askı Aparatı
Chain Hanger Apparatus

Kod / Code	LTS-1Y
Adet / Piece	2



M4 Fiberli Somun
M4 Fiber Nut

Kod / Code	LTS-1Y
Adet / Piece	8



Lotus Kol
Lotus Arm

Kod / Code	LTS-5
Adet / Piece	2



Vasistas Makas
Vasistas Scissors

Kod / Code	LTS-1Y
Adet / Piece	2



6001 Rulman
6001 Bearing

Kod / Code	LTS-1Y
Adet / Piece	1



Lotus Vida Seti
Lotus Bolt Set

Kod / Code	LTS-1Y
Adet / Piece	1



Lotus Zincirli Aksesuar Seti Yeni

Lotus Chain Accessories New Set



Motor Kutusu Çontası
Engine Box Seal

Kod / Code	GYT-28
Adet / Piece	75 Meters

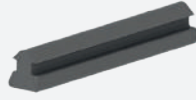

Kenetli Profil Çontası
Clamped Profile Bolt

Kod / Code	GYT-27
Adet / Piece	300 meters



67x800 Kil Fital
67x800 Bristle Wick

Kod / Code	GYT-29
Adet / Piece	250 meters



ERS 120 NM Elektronik Motor
ERS 120 NM Electronic Motor

Kod / Code	ERS-120NM-ELK
Adet / Piece	1



ERS Kumanda
ERS Control

Kod / Code	ERS-809
Adet / Piece	1



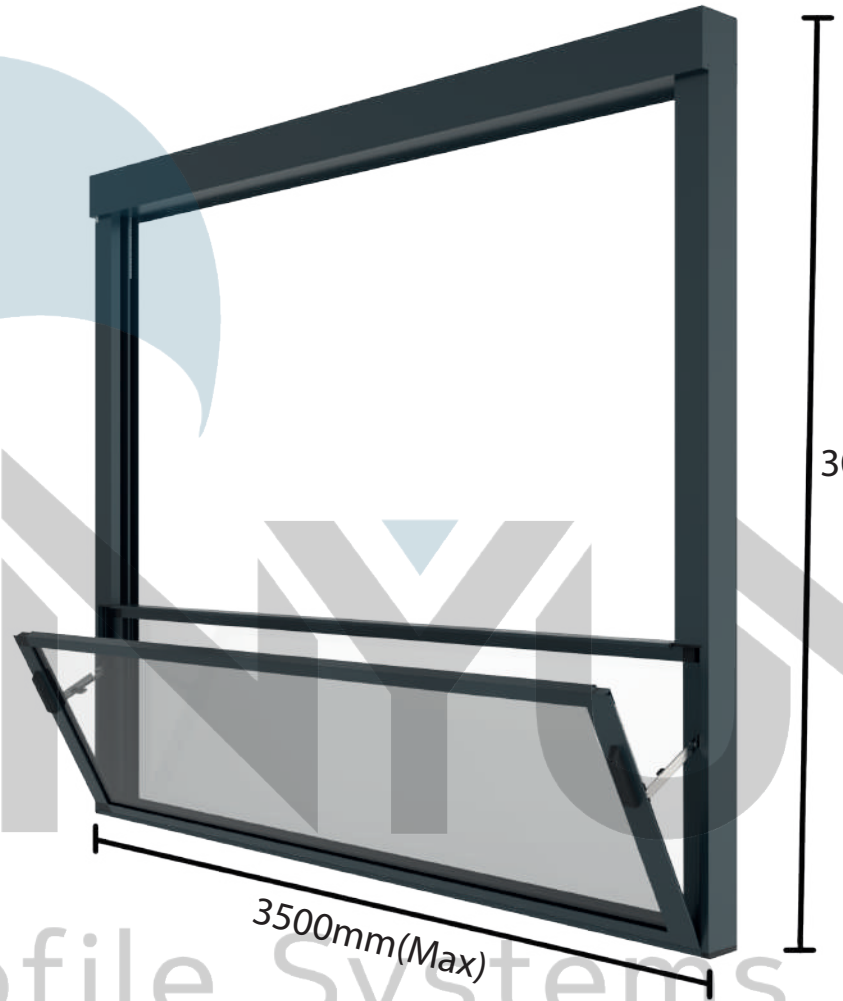
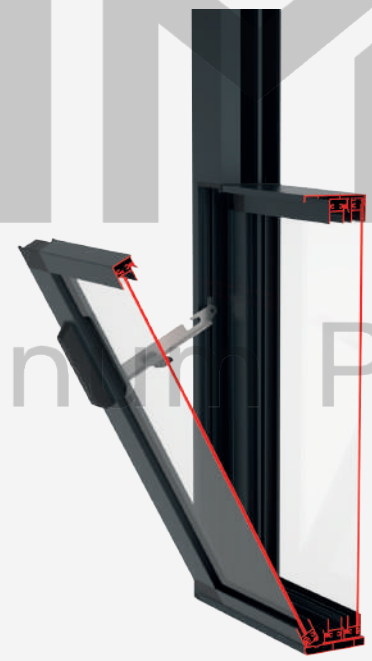
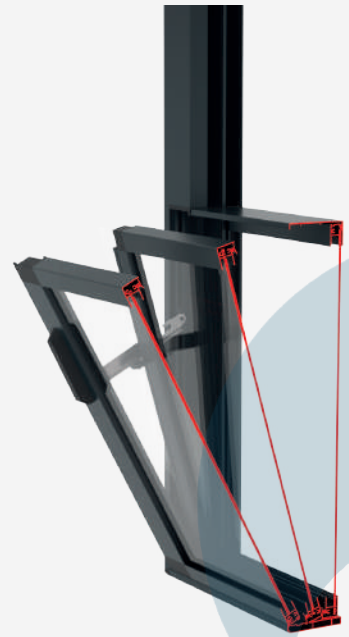

3000mm(Max)

3500mm(Max)

ART...
Aluminum Profile Systems



Aluminum Profile Systems

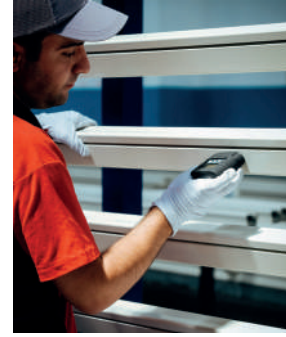
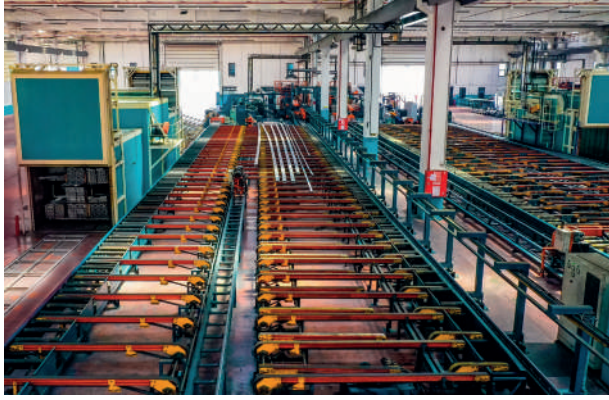

Biz Kimiz ?

Üstün kaliteli alüminyum profil üretimini her geçen gün artan standartlarla devam ettiren Kenan Metal A.Ş. ülkemizin önde gelen alüminyum fabrikalarından biridir. Mutlak müşteri ve çalışan memnuniyeti prensibiyle üretim yapan Kenan Metal A.Ş., tente pergola, inşaat ve özel profiller gibi farklı sektörlerin mevcut ve gelecekteki beklentilerini karşılayan, çevreyle dost üretim sistemlerini benimseyen, küresel etkileşimleri yakından takip ederek sürekli yenilenen, çağdaş bir vizyonla gelişiyor. Ürün-kalite çitasının sürekli yükseltilmesi, ürün yelpazesinin geliştirilmesi, yeni ürünlerin tasarımı, kullanım alanlarının artırılması için sürekli olarak çalışan Ar-Ge bölümüyle göz dolduran Kenan Metal A.Ş., kalitesi güvenilirliği, kullandığı teknoloji ve özel çözümler üretme gücüyle pazar payını sürekli genişletiyor.

Kenan Metal A.Ş., alüminyum bazlı ürünlerin kalitelerini artırarak ve kullanım alanlarını yaygınlaştırarak doğal ve estetik mekanların yaratılmasına da öncülük ediyor. Her yapı için kendine özgü üstün nitelikli ve ileri teknoloji gerektiren çağdaş çözümler sunan Kenan Metal A.Ş., esnek yaklaşımları üstün hizmet kalitesi ve fiyat-kalite dengesiyle küresel pazarda söz sahibi bir kurum olma yolunda emin adımlarla ilerliyor.

Who Are We?

Kenan Metal is one of the leading aluminum factories of our country which continues to produce high quality aluminum profiles with increasing standards each passing day. Kenan Metal which makes production with absolute customer and employee satisfaction principle, develops with a modern vision that meets current and future expectations of different sectors such as awning pergola, construction and special profiles, adopts environmentally friendly production systems, renews itself constantly by following global interactions closely.

Kenan Metal which makes a strong impression with its R&D department working constantly for raising product-quality level, improving product range, designing new products, increasing usage areas, expands its market share constantly with its quality, credibility technology used and power to produce special solutions

Kenan Metal is also leading creation of natural and aesthetic spaces by increasing quality of aluminum-based products and expanding usage areas. Kenan Metal which offers its unique, superior and modern solutions requiring advanced technology for every structure, is moving confidently on its way to become a promising company in global market with its flexible approaches, superior service quality and price-quality balance.



KENAN METAL®





kenanmetal.com | info@kenanmetal.com | +90 212 485 60 35

Genel Merkez : İosb Mh. Atatürk Blv. Mahmut Torun İş Merkezi No: 54 Kat: 1 34490 İkitelli Osb / Başakşehir / İstanbul
Fabrika : Velimeşe Mahallesi, Kandil Caddesi, 329 Sokak, Dış Kapı No:7 Ergene / Tekirdağ

